



2010-2019

HYUNDAI
ix 20 (JC)

KIA
Venga (YN)

Cat. No. J/042

E20

55R01/07*005976*00

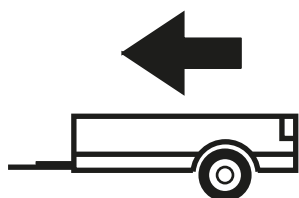

1 300kg

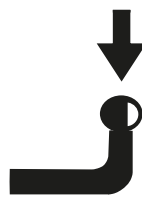

75kg

D = 7,43kN

D (kN) =



MAX kg

x

MAX kg

x 0,00981



MAX kg

+

MAX kg

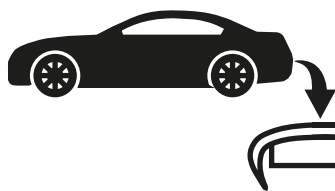

IMIOLA HAK-POL

96-111 KOWIESY, CHOJNATA 23A, POLAND

tel. +48 46 831 73 31, fax +48 831 74 29

e-mail: office@imiola.pl, www.imiola.pl

Rys. 25a

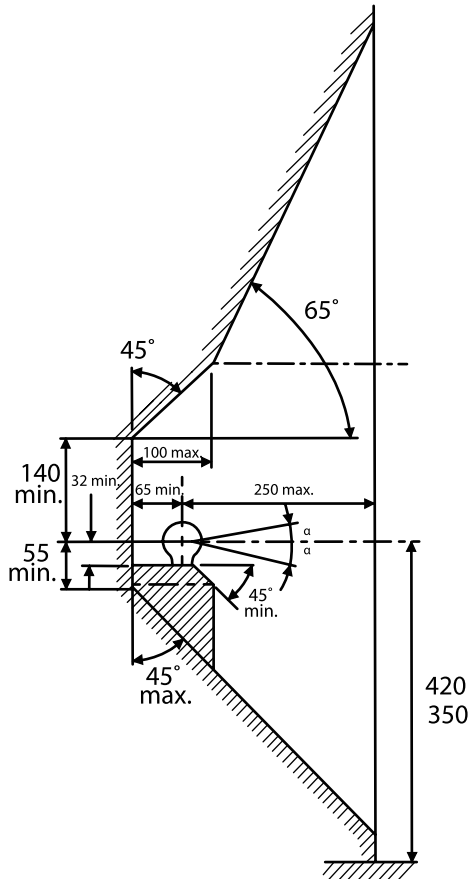

Rys. 25b

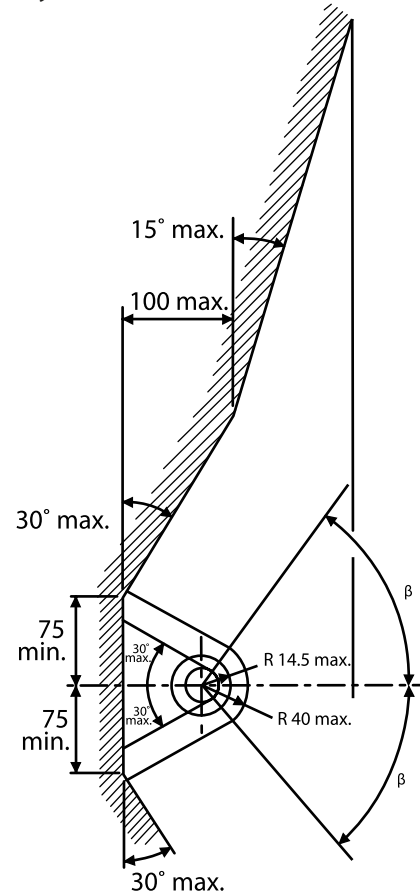

PL Należy zagwarantować przestrzeń swobodną według załącznika VII, rysunek 25a/b Regulaminu EKG ONZ 55.01 przy dopuszczalnym ciężarze całkowitym pojazdu.

FR L'espace libre doit être garanti conformément à l'annexe VII, illustration de la réglementation 55.01 CE pour un poids total en charge autorisé du véhicule.







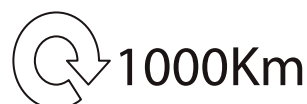

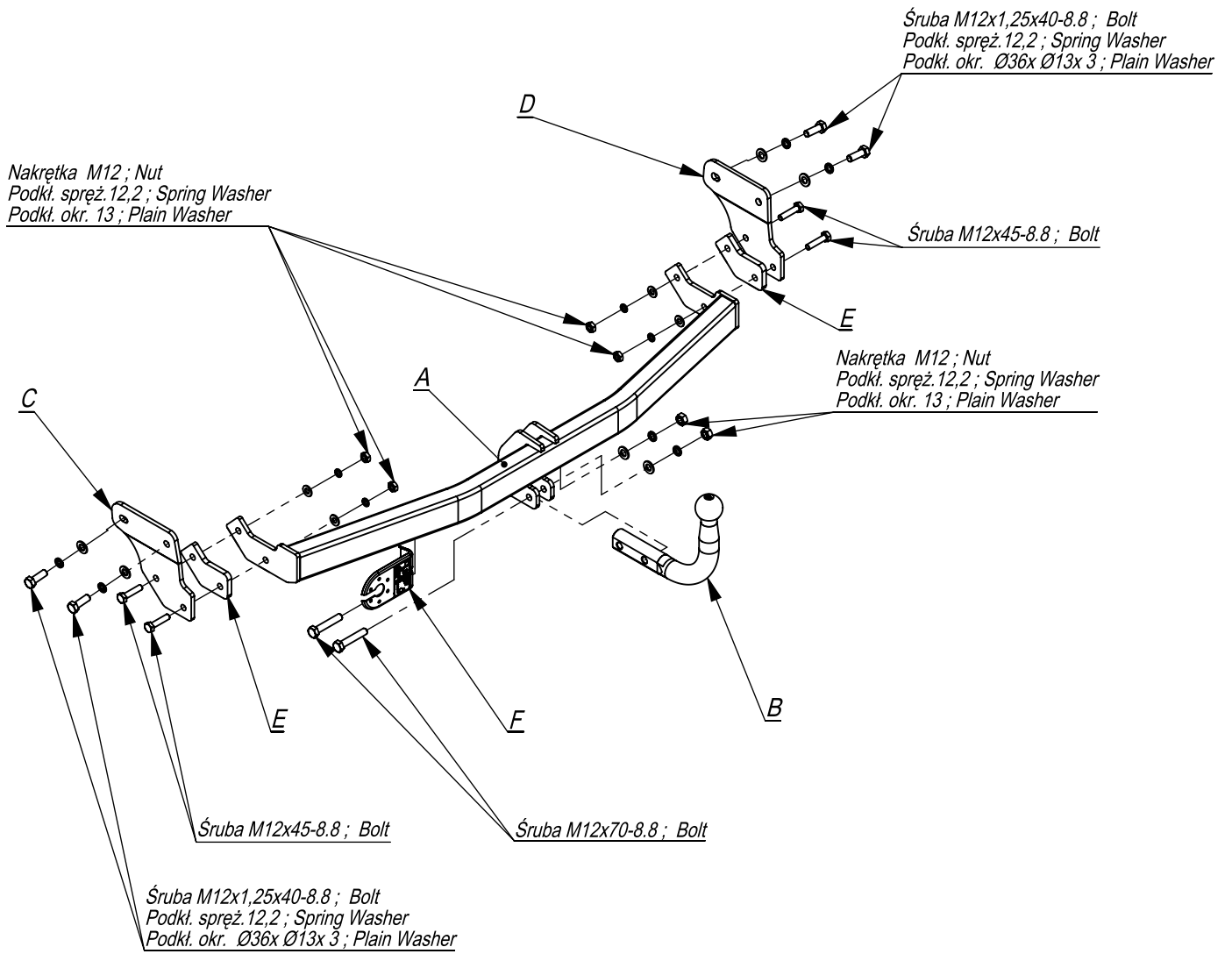

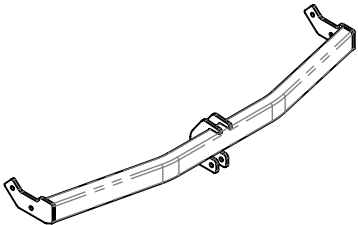
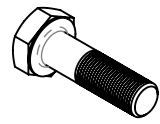
GB The clearance specified in appendix VII, diagram 25a/b of Regulation No. 55.01 UN EU must be guaranteed at laden weight of the vehicle.

DE Der Freiraum nach Anhang VII, Abbildung 25a/b der Vorschriften 55.01 EG ist zu gewährleisten bei zulässigem Gesamtgewicht des Fahrzeuges.

Moment skręcający dla śrub i nakrętek (8.8) Torque settings for nuts and bolts (8.8)	
M8	25Nm
M10	55Nm
M12	85Nm
M14	135Nm
M16	195Nm





	A	x1		M12x70	2
				M12x1,25x40	4
				M12x45	4
	B	x1		M12	6
	C	x1		Ø36xØ13x3	4
	D	x1		13	6
	E	x2		12,2	10
	F	x1			

Śruba M12x1,25x40-8.8 ; Bolt
 Podkł. spręż. 12,2 ; Spring Washer
 Podkł. okr. Ø36x Ø13x 3 ; Plain Washer

Śruba M12x45-8.8 ; Bolt

Nakrętka M12 ; Nut
 Podkł. spręż. 12,2 ; Spring Washer
 Podkł. okr. 13 ; Plain Washer

Śruba M12x70-8.8 ; Bolt

Śruba M12x45-8.8 ; Bolt

Śruba M12x1,25x40-8.8 ; Bolt
 Podkł. spręż. 12,2 ; Spring Washer
 Podkł. okr. Ø36x Ø13x 3 ; Plain Washer

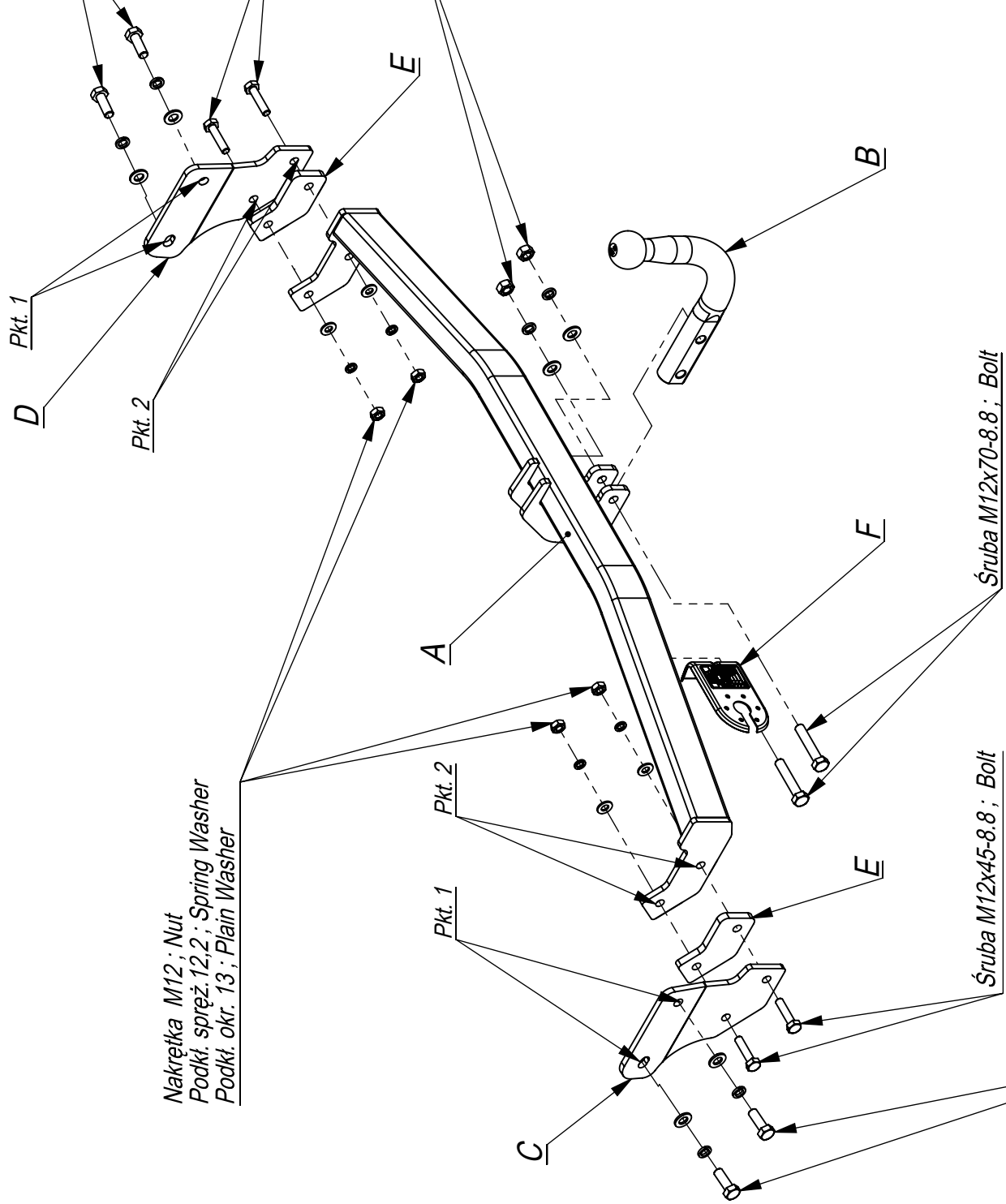

Nakrętka M12 ; Nut
 Podkł. spręż. 12,2 ; Spring Washer
 Podkł. okr. 13 ; Plain Washer

Nr katalogowy	2010-2019
J/042	2010-2019
Marka	
Hyundai ix20 (JC)	
KIA Venga (YN)	

