



03/2011 -

CHEVROLET AVEO 5D

Cat. No. CH/014

E20

55R-01 5352

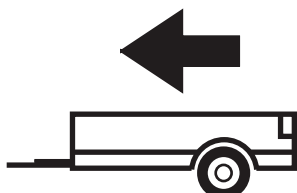

1100Kg

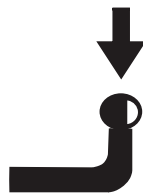

44Kg

D = 6,62kN

D (kN) =



MAX kg

x

MAX kg

x 0,00981



MAX kg

+

MAX kg



IMIOLA HAK-POL

96-111 KOWIESY, CHOJNATA 23A, POLAND

Tel. + 48 46 831 73 31, fax +48 831 74 29

e-mail: office@imiola.pl, www.imiola.pl

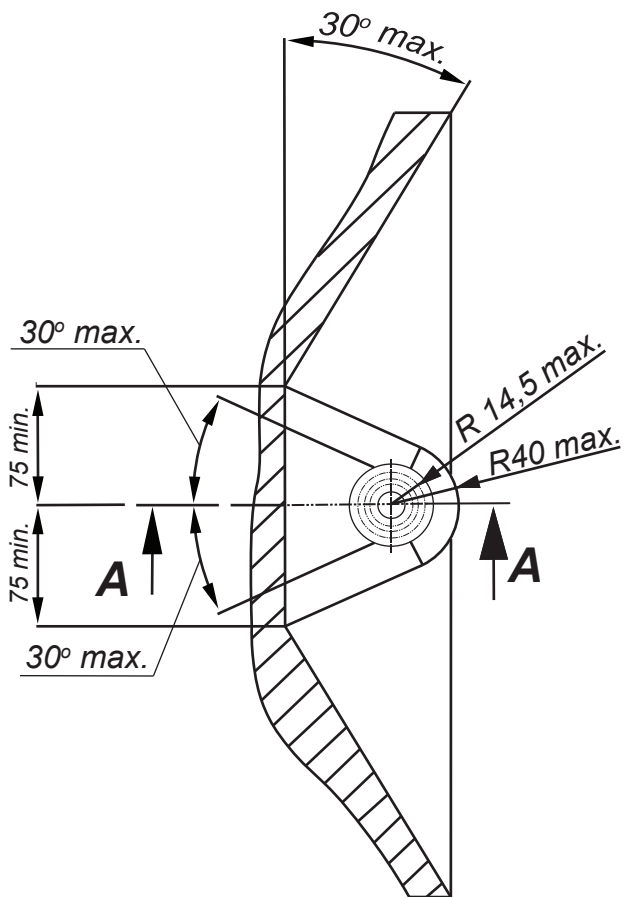

PRZEKRÓJ A-A

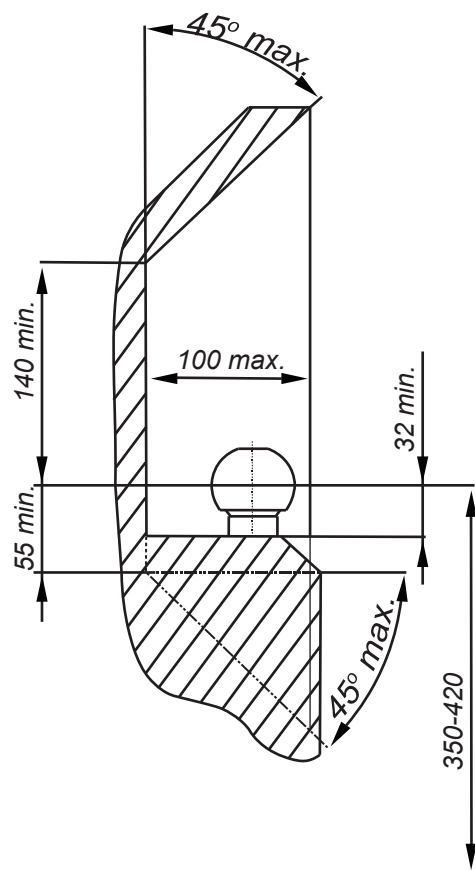

PL Należy zagwarantować przestrzeń swobodną według załącznika VII, rysunek 25a/b Regulaminu EKG ONZ 55.01 przy dopuszczalnym ciężarze całkowitym pojazdu.

F L'espace libre doit être garanti conformément à l'annexe VII, illustration de la réglementation 55.01 CE pour un poids total en charge autorisé du véhicule.

GB The clearance specified in appendix VII, diagram 25a/b of Regulation No. 55.01 UN EU must be guaranteed at laden weight of the vehicle.

D Der Freiraum nach Anhang VII, Abbildung 25a/b der Vorschriften 55.01 EG ist zu gew 25a/bahrleisten bei zulässigem Gesamtgewicht des Fahrzeuges.

Moment skręcący dla śrub i nakrętek (8.8) Torque settings for nuts and bolts (8.8)	
M8	25Nm
M10	55Nm
M12	85Nm
M14	135Nm
M16	195Nm



Śruba M10x30-8.8 ; Bolt
Podkł. spręż. 10,2 ; Spring Washer
Podkł. okr. Ø30x Ø10,5x 3 ; Plain Washer

Śruba M12x40-8.8 ; Bolt

Śruba M12x40 8.8 ; Bolt
Podkł. spręż. 12,2 ; Spring Washer
Podkł. okr. 13 ; Plain Washer

Nakrętka M12 ; Nut
Podkł. spręż. 12,2 ; Spring Washer
Podkł. okr. 13 ; Plain Washer

Śruba M10x30-8.8 ; Bolt
Podkł. spręż. 10,2 ; Spring Washer
Podkł. okr. Ø30x Ø10,5x 3
Plain Washer

Śruba M12x40 8.8 ; Bolt
Podkł. spręż. 12,2 ; Spring Washer
Podkł. okr. 13 ; Plain Washer

Śruba M10x45-8.8 ; Bolt
Podkł. spręż. 10,2 ; Spring Washer
Podkł. okr. Ø30x Ø10,5x 3 ; Plain Washer









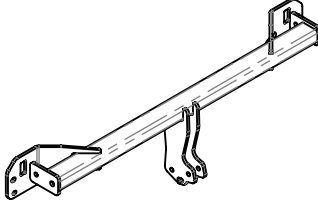
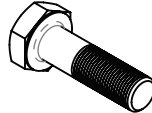
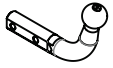

Śruba M12x40-8.8 ; Bolt

Śruba M12x40 8.8 ; Bolt
Podkł. spręż. 12,2 ; Spring Washer
Podkł. okr. 13 ; Plain Washer

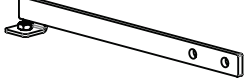
Śruba M12x70-8.8 ; Bolt

Śruba M12x40 8.8 ; Bolt
Podkł. spręż. 12,2 ; Spring Washer
Podkł. okr. 13 ; Plain Washer

Śruba M10x45-8.8 ; Bolt
Podkł. spręż. 10,2 ; Spring Washer
Podkł. okr. Ø30x Ø10,5x 3 ; Plain Washer

	A	x1		M12x70	2
				M12x40	6
				M10x45	4
				M10x30	2
	B	x1		M12	4
	C	x1		Ø30xØ10,5x3	6
	D	x1		13	8
	E	x1		12,2	8
	F	x1		10,2	6

Śruba M10x30-8.8 ; Bolt
 Podkł. spręż. 10,2 ; Spring Washer
 Podkł. okr. Ø30x Ø10,5x 3 ; Plain Washer

Nakrętka M12 ; Nut
 Podkł. spręż. 12,2 ; Spring Washer
 Podkł. okr. 13 ; Plain Washer

Śruba M10x30-8.8 ; Bolt
 Podkł. spręż. 10,2 ; Spring Washer
 Podkł. okr. Ø30x Ø10,5x 3
 Plain Washer

Śruba M12x40-8.8 ; Bolt

Śruba M12x40 8.8 ; Bolt
 Podkł. spręż. 12,2 ; Spring Washer
 Podkł. okr. 13 ; Plain Washer

Śruba M12x70-8.8 ; Bolt

Śruba M12x40 8.8 ; Bolt
 Podkł. spręż. 12,2 ; Spring Washer
 Podkł. okr. 13 ; Plain Washer

Śruba M12x40 8.8 ; Bolt
 Podkł. spręż. 12,2 ; Spring Washer
 Podkł. okr. 13 ; Plain Washer

Śruba M12x40 8.8 ; Bolt
 Podkł. spręż. 12,2 ; Spring Washer
 Podkł. okr. 13 ; Plain Washer

Śruba M10x45-8.8 ; Bolt
 Podkł. spręż. 10,2 ; Spring Washer
 Podkł. okr. Ø30x Ø10,5x 3 ; Plain Washer

Śruba M10x45-8.8 ; Bolt
 Podkł. spręż. 10,2 ; Spring Washer
 Podkł. okr. Ø30x Ø10,5x 3 ; Plain Washer

