



Cat. No. **A/A14**

Audi A4 Sedan (incl. S-line)

2007-12/2015

Audi A4 Avant (incl. S-line)

2008-12/2015

Audi A5 Coupe

2007-2016

e20

e20*94/20*1701*00

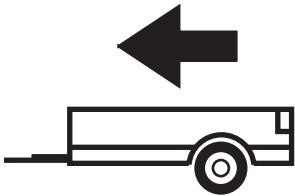

2100kg



90kg

D = 10,90kN

D (kN) =



MAX kg

x

MAX kg

x 0,00981



MAX kg

+

MAX kg



IMIOLA HAK-POL

96-111 KOWIESY, CHOJNATA 23A, POLAND

Tel. + 48 46 831 73 31, fax +48 831 74 29

e-mail: office@imiola.pl, www.imiola.pl

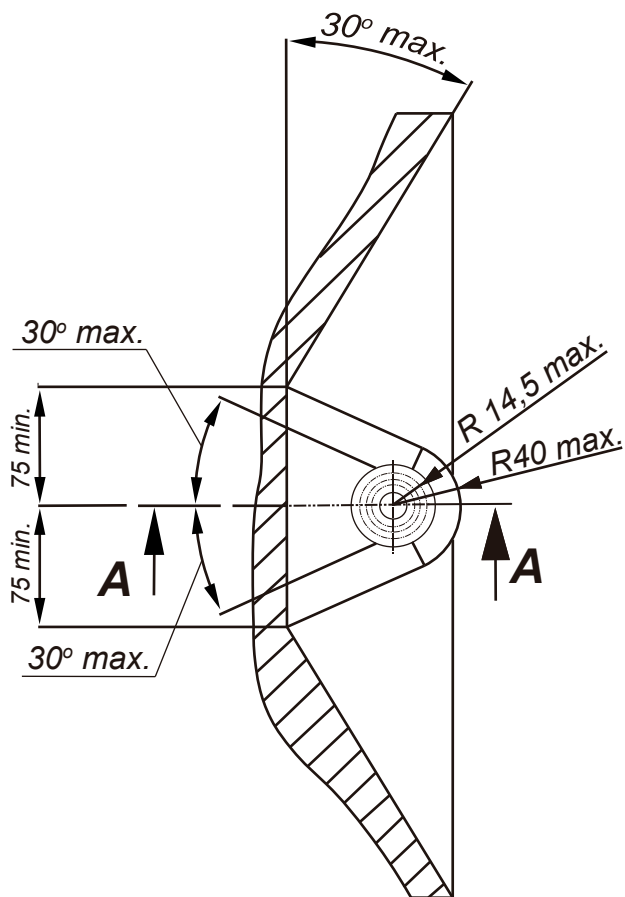

PRZEKRÓJ A-A

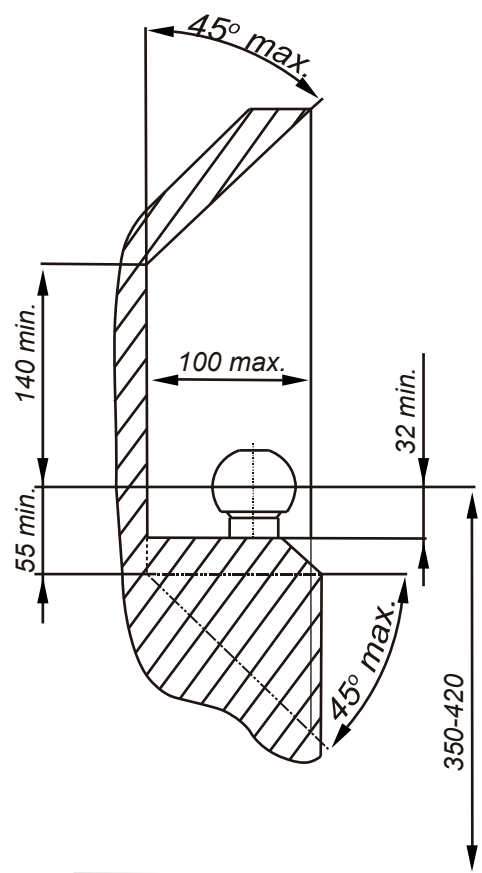

PL Należy zagwarantować przestrzeń swobodną według załącznika VII, rysunek 25a/b Regulaminu EKG ONZ 55.01 przy dopuszczalnym ciężarze całkowitym pojazdu.

F L'espace libre doit être garanti conformément à l'annexe VII, illustration de la réglementation 55.01 CE pour un poids total en charge autorisé du véhicule.

GB The clearance specified in appendix VII, diagram 25a/b of Regulation No. 55.01 UN EU must be guaranteed at laden weight of the vehicle.

D Der Freiraum nach Anhang VII, Abbildung 25a/b der Vorschriften 55.01 EG ist zu gew 25a/bahrleiten bei zulässigem Gesamtgewicht des Fahrzeuges.

Moment skręcający dla śrub i nakrętek (8.8) Torgue settings for nuts and bolts (8.8)	
M8	25Nm
M10	55Nm
M12	85Nm
M14	135Nm
M16	195Nm

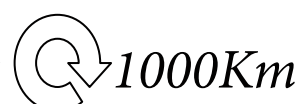

Nakrętka M12; Nut
 Podkł. spręż. 12,2; Spring Washer
 Podkł. okr. 13; Plain Washer

Śruba M10x100-8.8; Bolt
 Podkł. okr. 10,5; Plain Washer

Śruba M10x100-8.8; Bolt
 Podkł. okr. Ø30x Ø10,5x 3; Plain Washer

Nakrętka M10; Nut
 Podkł. spręż. 10,2; Spring Washer
 Podkł. okr. Ø30x Ø10,5x 3; Plain Washer

Śruba M10x100-8.8; Bolt
 Podkł. spręż. 10,2; Spring Washer
 Podkł. okr. Ø30x Ø10,5x 3; Plain Washer

Śruba M12x40-8.8; Bolt









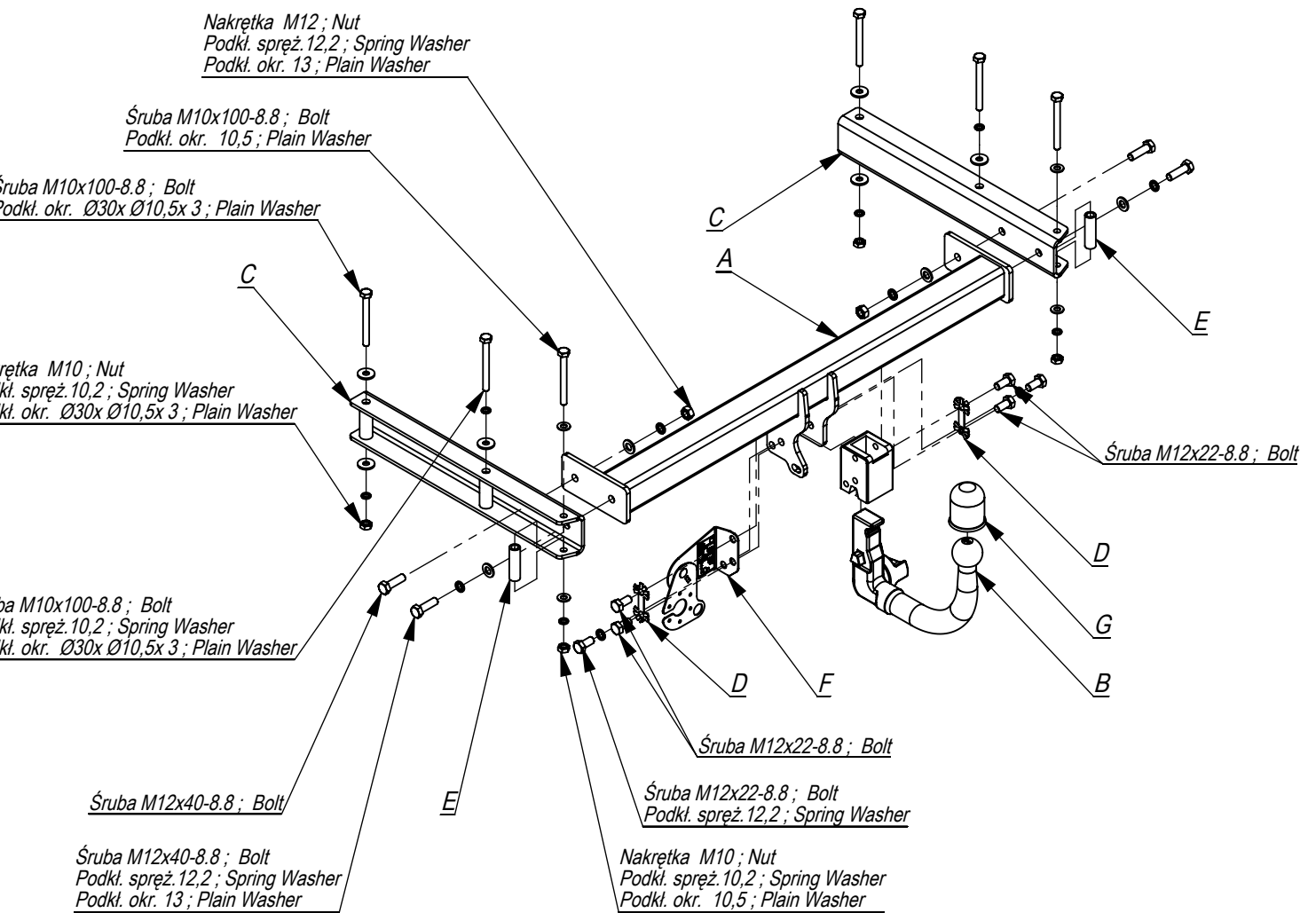

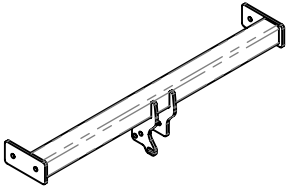
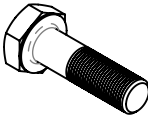
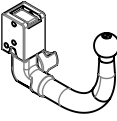
Śruba M12x40-8.8; Bolt
 Podkł. spręż. 12,2; Spring Washer
 Podkł. okr. 13; Plain Washer

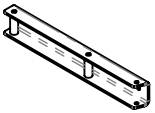
Śruba M12x22-8.8; Bolt
 Podkł. spręż. 12,2; Spring Washer

Nakrętka M10; Nut
 Podkł. spręż. 10,2; Spring Washer
 Podkł. okr. 10,5; Plain Washer

Śruba M12x22-8.8; Bolt



	A	x1		M12x40	4
				M12x22	6
				M10x100	6
	B	x1		M12	2
				M10	4
	C	x2		Ø30xØ10,5x3	6
				13	4
	D	x2		10,5	4
				12,2	6
Ø18x3,2x62 	E	x2		10,2	6
	F	x1			
	G	x1			

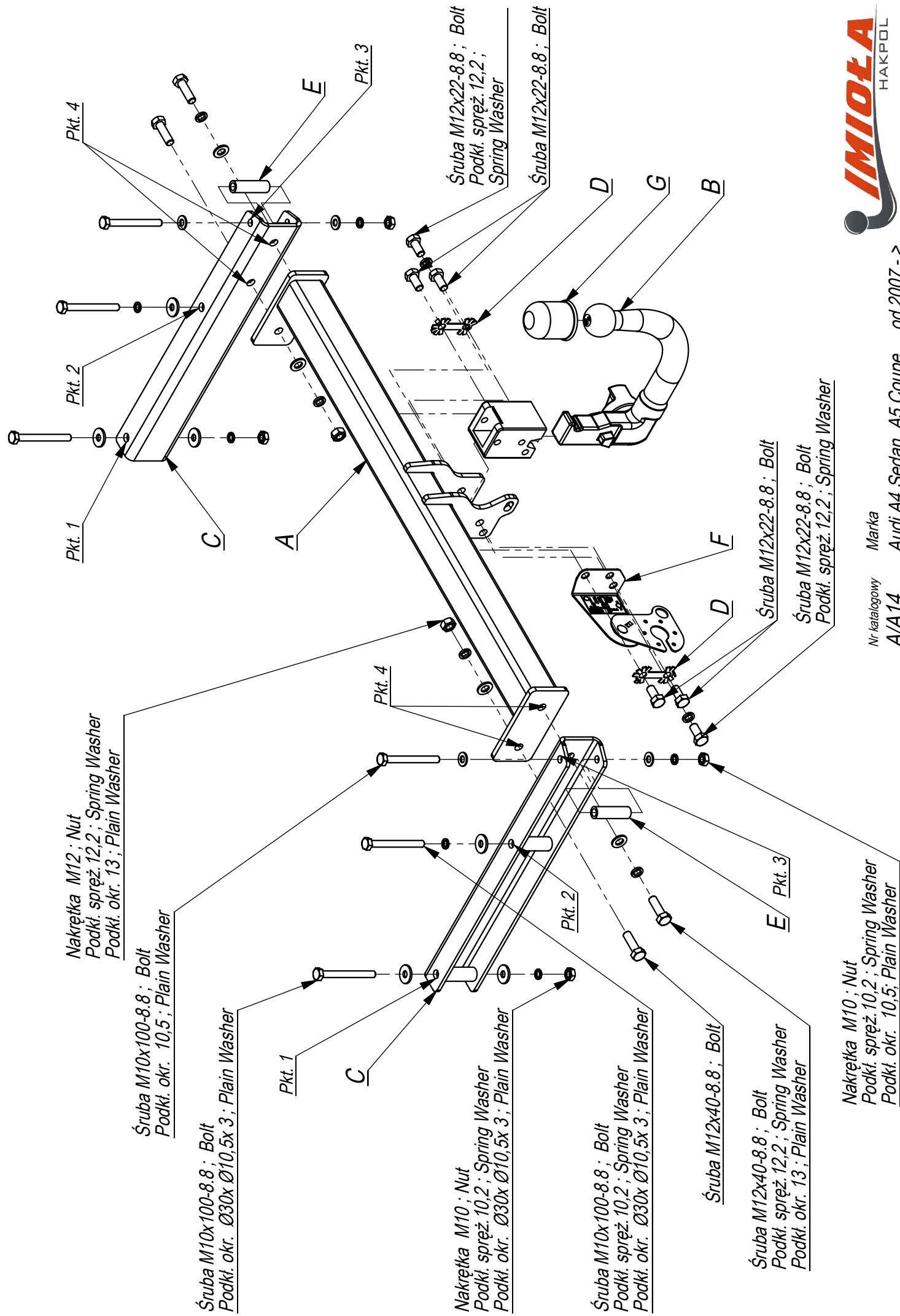

- Odkręcić zderzak.
- Odkręcić plastikowe elementy w bagażniku.
- Odkręcić belkę zderzeniową i usunąć elementy mocujące belkę.
- Do podłużnic wsunąć elementy haka C i poprzez technologiczne otwory w podłużnicach przykręcić lekko element C śrubami M10x100 8.8 (pkt 1 i 2).
- Do elementów C przykręcić belkę haka A śrubami M12x40 8.8 (pkt 4).
- Do elementów C przykręcić wzmocnienie zderzaka śrubami M10x100 8.8 (pkt 3) stosując tuleje D.
- Wszystkie śruby dokręcić z momentem wg tabeli.
- Wykonać w zderzaku wycięcie na łapki kuli.
- Przykręcić zderzak.
- Przykręcić kulę i blachę gniazda elektrycznego.
- Podłączyć instalację elektryczną.
- Przykręcić plastikowe elementy w bagażniku.

- Unscrew the bumper.
- Unscrew the plastic elements in the boot.
- Unscrew the bumper bar and remove the bar tting elements.
- Insert elements C in the metal clamps and screw slightly, through the technological holes in the metal clamps, with bolts M10x100 8.8 (point 1 and 2).
- Screw the main bar A to the elements C with bolts M12x40 8.8 (point 4).
- Screw the reinforcement of the bumper to the elements C with bolts M10x100 8.8 (point 3) using sleeves D.
- Tighten all the bolts according to the torque setting- see the table.
- Cut out the fragment in the bumper to place the handles of the ball.
- Screw the bumper.
- Fix the ball and electric plate.
- Connect the electric wires.
- Screw the plastic elements in the boot.

- Déposer le pare-choc,
- Démonter les carters en plastique dans le core, enlever le revêtement.
- Dévisser la poutre pare-chocs et retirer les éléments de fixation de la poutre.
- Insérer les éléments C du crochet dans les longerons, Serrer legerement les boulons M10x100 8.8 (point 1) a travers les ouvertures,
- Serrer la traverse du crochet A aux éléments C avec de boulons M12x40 8.8 (point 4),
- Les éléments C fixent les boulons de renfort de pare-chocs M10x100 8,8 (point 3) en utilisant des douilles D.
- Serrer tous les boulons avec un couple de serrage selon tableau,
- Ouvrir l'axe de pare-chocs en partie basse.
- Serrer le pare-chocs.
- Visser la boule et la tôle de la prise électrique avec les boulons M12x25 8.8
- Raccorder le circuit électrique.

- Die Stoßstange demontieren.
- Die Plastikelemente im Koerraum abschrauben.
- Den Stoßstange Balken abschrauben, den Balken befestigenden Elemente entfernen.
- In die Längsträger die Tragteile C schieben, durch die vom Werk aus vorhandenen Öffnungen in den Längsträgern, das Tragteil C mit den Schrauben M10x100 8.8 (Punkt 1 und 2) locker anschrauben.
- An die Tragteile C den Querbalken A mit den Schrauben M12x40 8.8 (Punkt 4) anschrauben.
- An die Tragteile C die Stoßstange Verstärkung mit den Schrauben M10x100 8.8 (Punkt 3) mit der Anwendung von Hülsen anschrauben.
- Alle Schrauben mit dem in der Tabelle angegebenen Drehmoment festschrauben.
- In der Stoßstange einen Ausschnitt für die Klappen der Kugel ausführen.
- Die Stoßstange einbauen.
- Die Kugel und die Steckdosenhalterung anschrauben.
- Die Elektroinstallation anschließen.
- Die Plastikelemente im Koerraum anschrauben.

- Desenroscar el parachoques.
- Desenroscar las piezas de plástico en el maletero.
- Desmontar la barra del parachoques y quitar los elementos de fijación de la barra.
- Insertar los elementos del gancho C al chasis ya través de las aberturas tecnológicas del chasis, apriete ligeramente el elemento C con tornillos M10x100 8.8 (puntos 1 y 2).
- Atornillar la viga de la bola de remolque A a los elementos C usando tornillos M12x40 8.8 (punto 4).
- Apretar el soporte del parachoques a los elementos C con tornillos M10x100 8.8 (punto 3) utilizando los bujes D.
- Apretar todos los tornillos con el par según la tabla anterior.
- Hacer un corte en el parachoques para las garras de la bola.
- Atornillar el parachoques.
- Apretar la bola y la placa de la toma eléctrica.
- Conectar la instalación eléctrica.
- Apretar los elementos de plástico en el maletero.

