

# No. 21500551

## ŠKODA

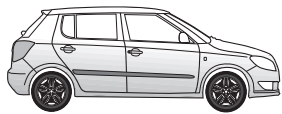

Fabia 06/10 → 10/14

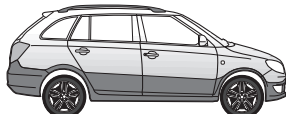

Fabia Scout 06/10 →



Fabia Kombi 06/10 → 12/14

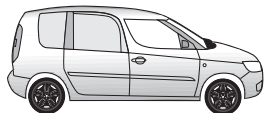

Roomster 06/10 →

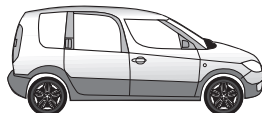

Roomster Scout 06/10 →

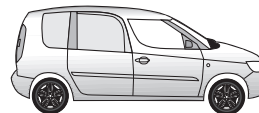

Praktik 06/10 →

**PL**

Zestaw elektryczny do haka holowniczego / 13-biegunowy / 12 Volt / ISO 11446

## Instrukcja montażu

**SK**

Elektrosada pre tazne zariadenie / 13-pol / 12 Volt / ISO 11446

## Navod na použitie

**GB**

Electric wiring kit for towbars / 13-pin / 12 Volt / ISO 11446

## Fitting instructions

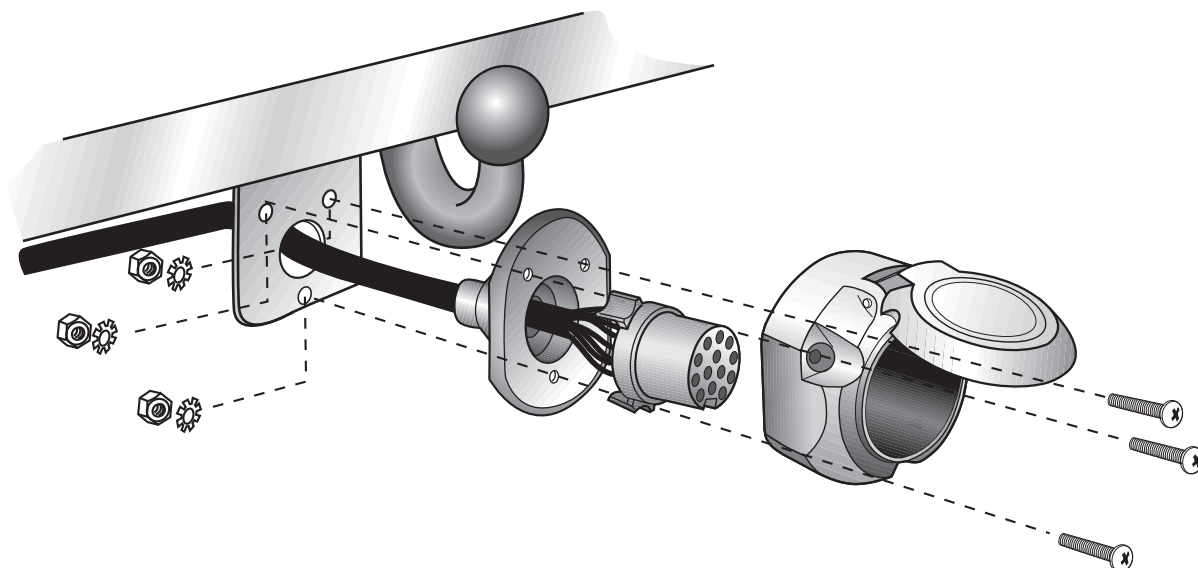

## UWAGA!

PL

Przed rozpoczęciem montażu wiazki elektrycznej należy dokładnie zapoznać się z dołączoną instrukcją. Po zamontowaniu wiazki do samochodu instrukcje montażu należy dołączyć do dokumentacji samochodu. Montaż wiazki elektrycznej musi być przeprowadzony przez specjalistyczny warsztat samochodowy. Montaż wiazki przez osoby niewykwalifikowane, lub dokonywanie zmian w połączeniach wiazki (niezgodnych z dołączoną instrukcją) powoduje utratę gwarancji. Zamiana elektronicznych podzespołów w wiazce jest zabroniona. W przypadku jazdy bez przyczepy reduktory nie mogą pozostawać w gnieździe.

Zmiany w instrukcji montażu wiazki dotyczące konstrukcji, wyposażenia kolorów, błędów mogą się zdarzyć. W przypadku gdy przyczepa nie jest wyposażona w światło przeciwmgiełne, należy je zamontować.

Za wszystkie zmiany techniczne i elektroniczne dokonane w samochodzie lub w przyczepie po montażu wiazki i mające bezpośredni wpływ na jej działanie nie bierzemy odpowiedzialności.

Między modulem sterującym w wiazce elektrycznej a modulem sterującym samochodem nie ma bezpośredniej komunikacji. W przypadku gdy moduł sterujący samochodem generuje komunikat o błędach, które są bezpośrednie lub pośrednio spowodowane przez moduł wiazki elektrycznej, należy ten moduł odłączyć i przeprowadzić test ponownie.

## POZOR!

SK

Montáž tejto elektrosady musí byť prevedená v špecializovanom servise alebo primerane kvalifikovanou osobou. Pred začatím montáže je nutné dôkladne si prečítať návod na použitie.

Po ukončení montáže je potrebné tento návod odložiť ku servisným dokumentom vozidla.

Pri neodbornej montáži alebo zmene elektrosady, prípadne zmene existujúcich súčiastok, zanika akýkoľvek nárok na záruku. Pri jazde bez prívesu je nutné odpojiť adapter zo zásuvky (ak je tento prevádzka). Zmeny týkajúce sa konštrukcie, vybavenia, farieb, ako aj omyly sú vyhradené. Všetky špecifikácie a ilustrácie sú nezáväzná.

Ak príves nie je vybavený hmlovým svetlom, je potrebné ho dodatočne namontovať.

Za technické zmeny, prípadne zmeny elektroniky, ktoré boli uskutočnené výrobcou vozidla po uvedení elektrosady do prevádzky a ktoré vedú k chybným funkciám zásuvky alebo prídavných zariadení, nepreberáme žiadne záruky.

Modul prívesu nie je schopný komunikovať s diagnostickým zariadením. V prípade, že testovacie mechanizmy generujú chybný protokol pri diagnostike, súvisiaci s tým priamo alebo nepriamo s prevádzkou prívesu, je nutné odpojiť modul prívesu od elektrosady a opakovane vykonať diagnostiku.

## IMPORTANT!

GB

Installation of the towing electrics kit must be undertaken by a specialist workshop or an appropriately qualified person. Before starting work, you must read the installation instructions through completely. After installing the towing electrics kit, the installation instructions should be kept with the vehicle service documentation.

All claims under the guarantee will lapse in case of improper use or modification of the towing electrics kit or any of its component parts. When driving without a trailer or load carrier, any adapter installed must be removed from the electrical socket. We reserve the right to alter the design, content or colour. We accept no liability for any errors in these instructions. All details and illustrations are non-binding.

In case of missing a rear fog lamp on the trailer, it should be retrofitted.

We accept no responsibility and give no guarantee for technical and electrical modifications made after the initial operation of the towing electrics kit by the vehicle manufacturer and which may lead, for example to malfunction of the trailer socket or its peripheries.

The trailer module is not diagnostics-capable. If the manufacturer's diagnostics processes or software-supported test mechanisms generate error reports directly or indirectly linked with trailer operation, the trailer module must be disconnected from the leads to the trailer socket and a new diagnostic process initiated.

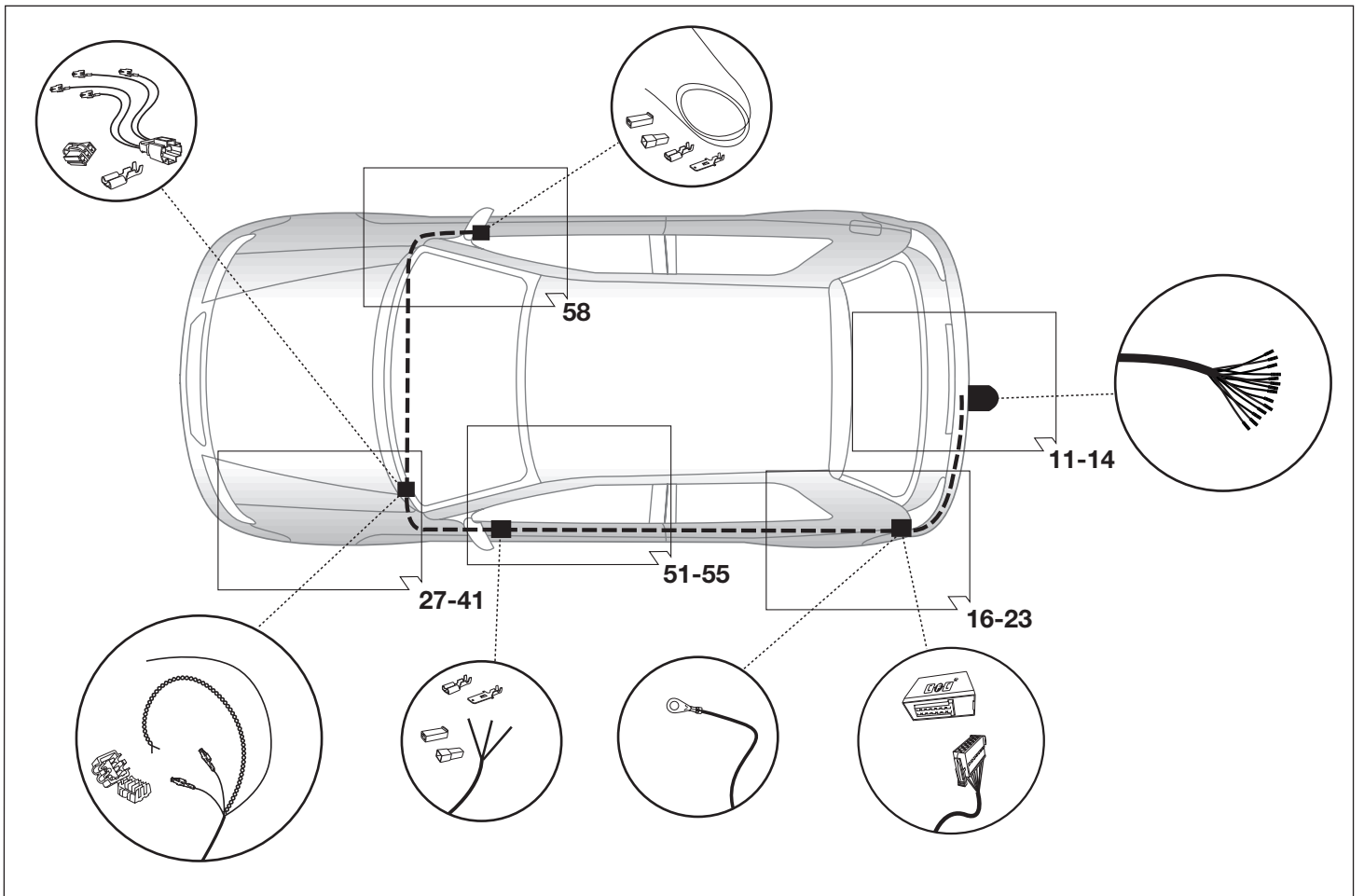
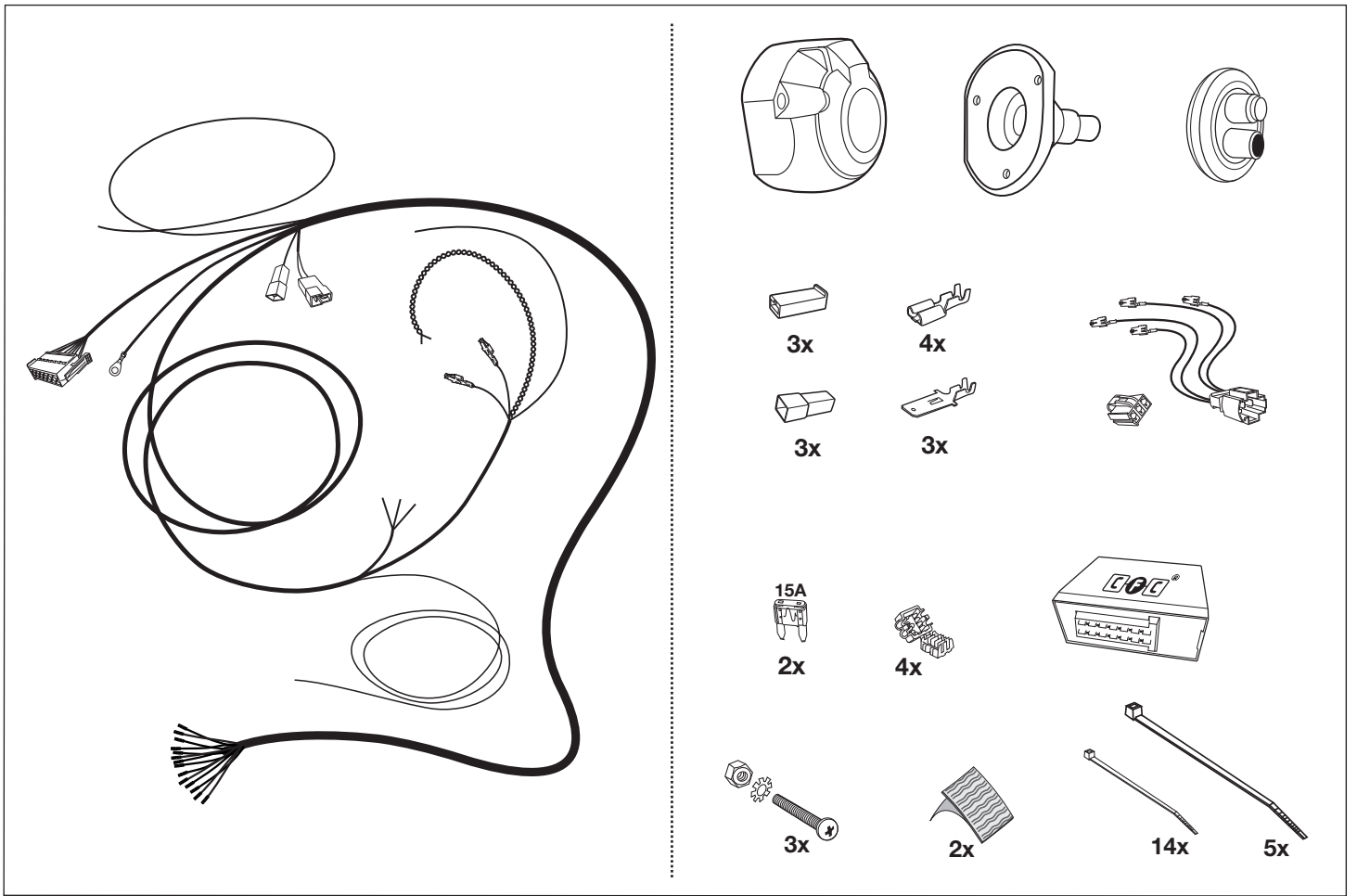

## Narzedzia - Nastroje - Tools

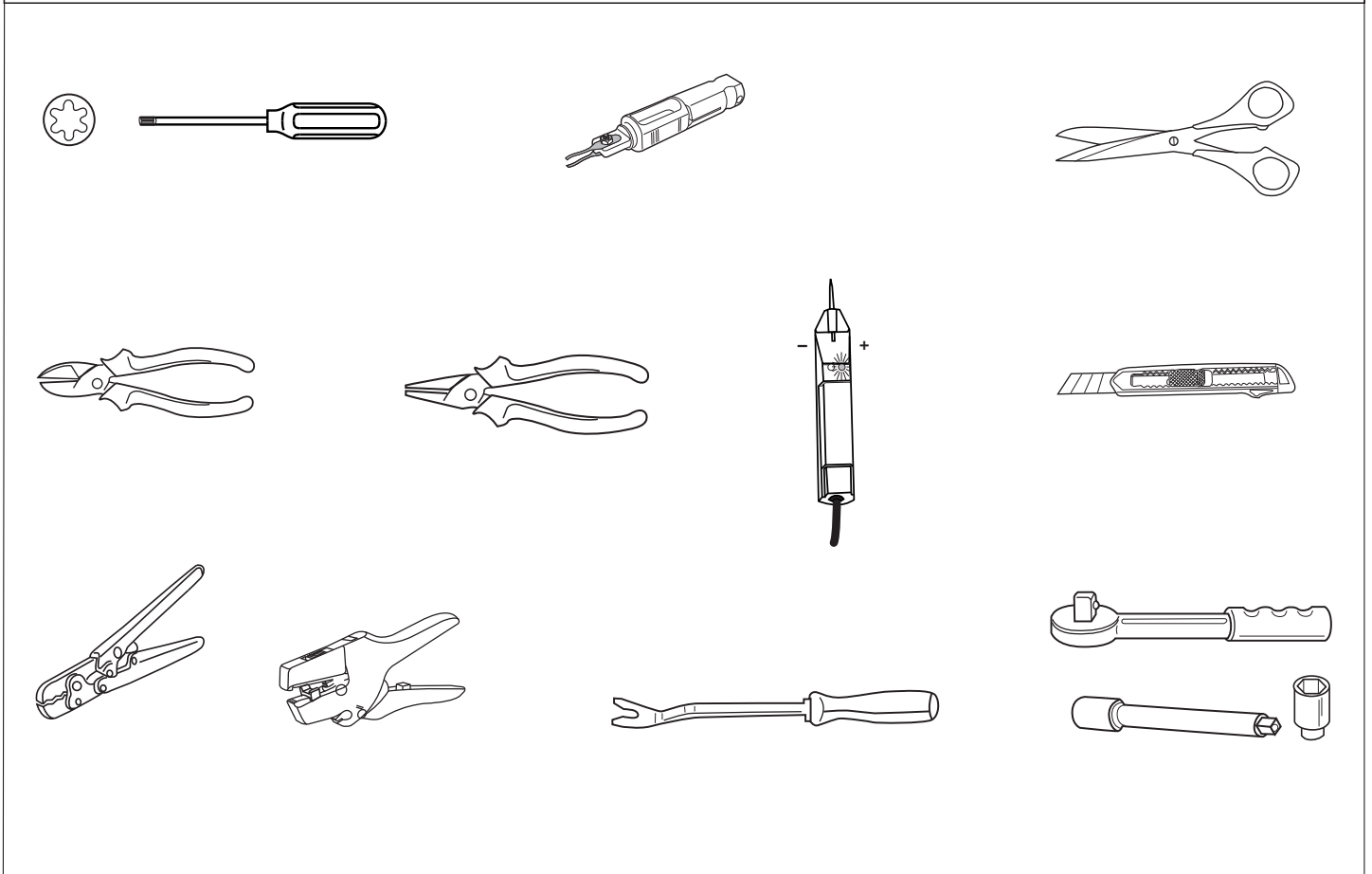

**UWAGA!**

**(PL)**

Wydajność układu chłodzenia w zależności od możliwości musi być zwiększona w przypadku zamontowania dodatkowego wyposażenia (hak holowniczy). Proszę koniecznie zniebac o zalecenie producenta samochodu !!

**POZOR!**

**(SK)**

Vykon chladica vozidla musi byt pri doplneni vybavy o tazne zariadenie podla možnosti zvyšeny !!  
Prosime bezpodmienečne dbat na pokyny výrobcu !!

**ATTENTION!**

**(GB)**

The vehicle's cooling capacity may have to be increased when retrofitting a trailer coupling!  
You must observe the manufacturer's instructions!!

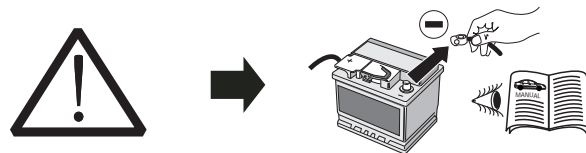

**UWAGA!**

**(PL)**

Aby zapobiec zbyt dużym błędom w elektronice samochodu, należy przed rozpoczęciem montażu wiązki odłączyć клемę (-) MINUS od akumulatora!

W Przypadku nieodłączenia клемy szczególnie przy montażu modułu CFC (CAN Bus) może nastąpić uszkodzenie tego modułu w wiązce jak również uszkodzenie modułu sterującego w samochodzie!

Dla tego prosimy przestrzegać instrukcji producenta przy odłączaniu i załączaniu клемy akumulatora!

**POZOR!**

**(SK)**

Aby sa zabranilo zbyt veľkym chybam v palubnej sieti, musi byt odpojena akumulátorova svorka na negativny (minus) pol este pred začatím montáže!

Obzvlášť pri prácach a pripojeniach na CAN-dátovej zbernici môže dôjsť pri neodpojení akumulátorovej svorky k poškodeniu modulu privesu, ako aj k poškodeniu palubného modulu vozidla!

Prosime dodržiavať pokyny výrobcu pri odpojení a pripojení akumulátora!

**ATTENTION!**

**(GB)**

In order to avoid malfunctions and damage to the vehicle's electrical system, the earth terminal must be disconnected from the vehicle's battery before starting work!

Both the trailer module and the vehicle's control unit for the electrical system can be damaged during work on the CAN data bus connections if the battery is not disconnected!

Please pay attention to the manufacturer's instructions when disconnecting and reconnecting the vehicle's battery!

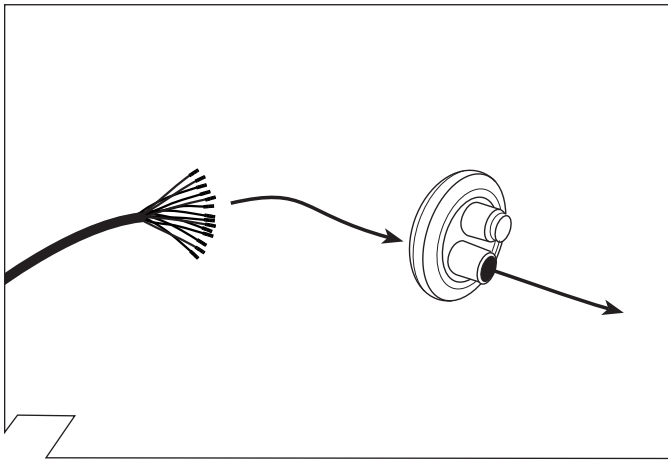

2

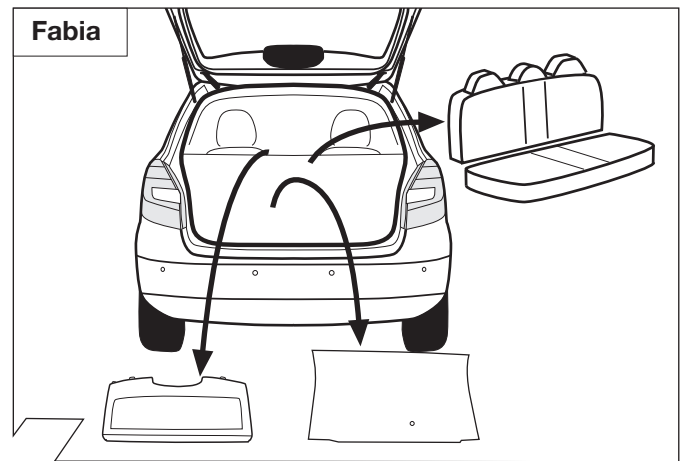

3

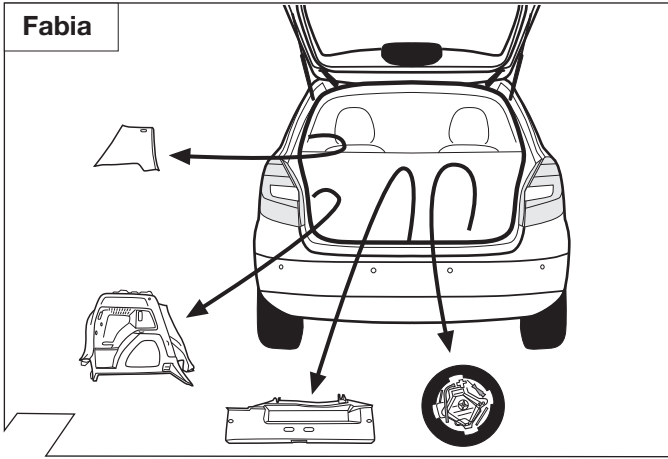

4

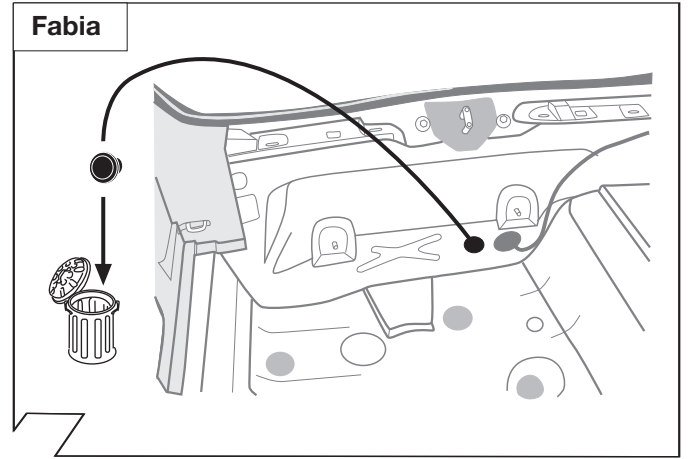

5

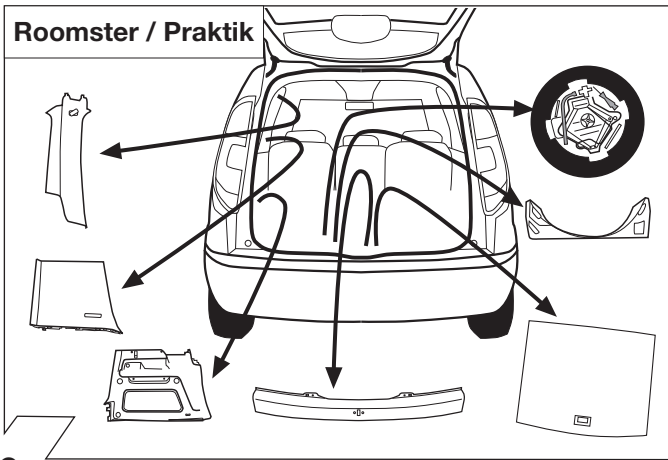

6

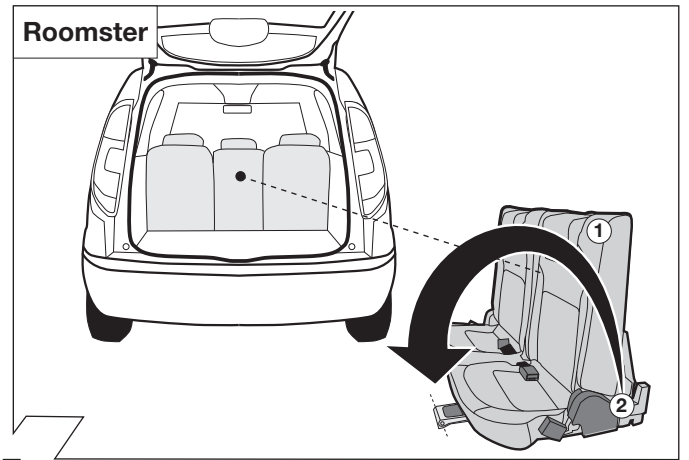

7

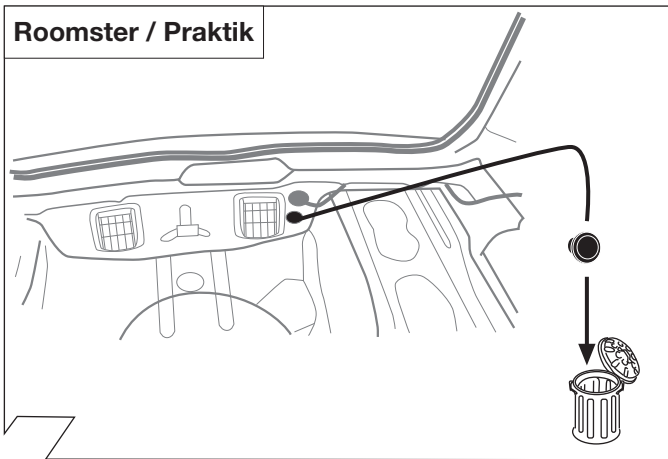

8

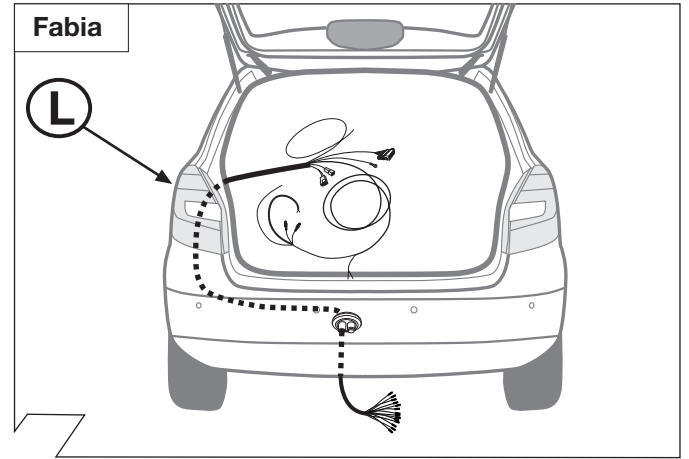

9

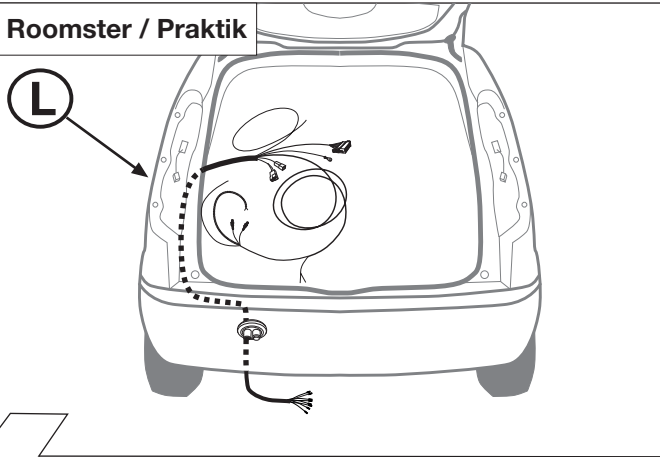

10

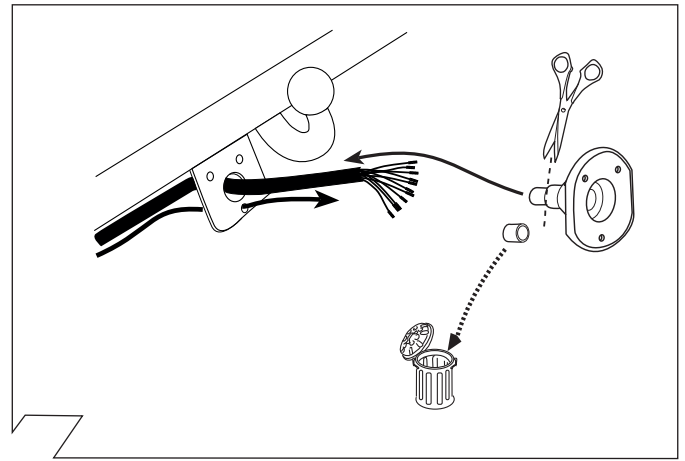

11

ISO 11446	Podłączenie gniazda / Maksymalne obciążenie na wyjściu Obloženie zasuvky/Maximalny výkon na vystupe Socket Configuration/Maximum power output		
	1/L	BK/WT	21W
	2	WT	42W
	2a	BK	
	1-8	BR	
	4/R	BK/GN	21W
	5/58-R	GY/RD	52W
	6/54	BK/RD	63W
	7/58-L	GY/BK	52W
	8	BL/RD	42W
	9	RD	240W
	10	YL	180W
	11	YL/BR	
	12		
	13	RD/BR	

12

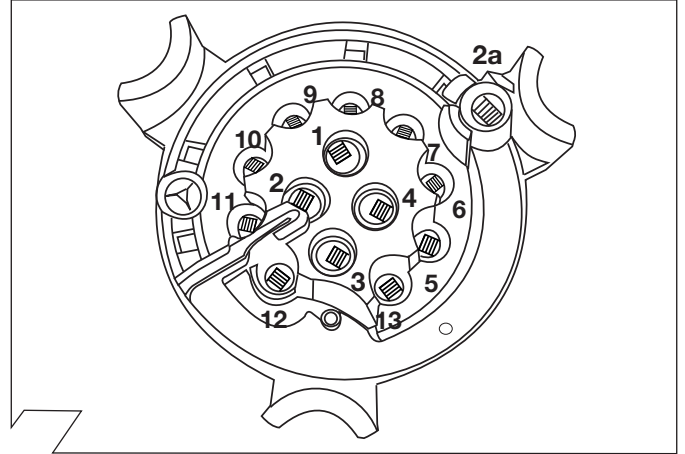

13

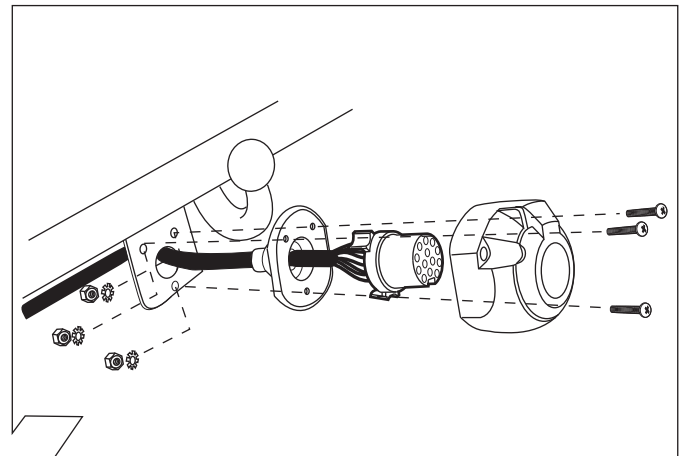

14

	GB	D	E	F	I	P	NL	DK	N	S	FIN	CZ	H	PL
<b>BK</b>	Black	Schwarz	Negro	Noir	Nero	Preto	Zwart	Sort	Svart	Svart	Musta	Černá	Fekete	Czarny
<b>RD</b>	Red	Rot	Rojo	Rouge	Rosso	Vermelho	Rood	Röd	Röd	Röd	Punainen	Červená	Piros	Czerwony
<b>GN</b>	Green	Grün	Verde	Vert	Verde	Verde	Groen	Gron	Grønt	Grön	Vihreä	Zelená	Zöld	Zielony
<b>OR</b>	Orange	Orange	Naranja	Orange	Arancione	Laranja	Oranje	Orange	Orange	Orange	Oranssi	Oranzová	Narancs	Pomarańczowy
<b>VT</b>	Violet	Violett	Violeta	Violet	Viola	Violeta	Violet	Violet	Fiolett	Violett	Violetti	Fialová	Ibolya	Fioletowy
<b>PK</b>	Pink	Pink	Pink	Rose	Rosa	Cor-de-Rosa	Paars	Pink	Pink	Rosa	Pinkki	Růžová	Rózsaszín	Różowy
<b>BL</b>	Blue	Blau	Azul	Bleu	Blu	Azul	Blauw	Blå	Blått	Blå	Sininen	Modrá	Kék	Niebieski
<b>YL</b>	Yellow	Gelb	Amarillo	Jaune	Giallo	Amarelo	Geel	Gul	Gult	Gul	Keltainen	Zlutá	Sárga	Żółty
<b>WT</b>	White	Weiss	Blanco	Blanc	Bianco	Branco	Wit	Hvid	Hvitt	Vit	Valkoinen	Bílá	Fehér	Biały
<b>BR</b>	Brown	Braun	Marrón	Brun	Marrone	Marrom	Bruin	Brun	Brunt	Brun	Ruskea	Hnědá	Barna	Brazowy
<b>GY</b>	Grey	Grau	Gris	Gris	Grigio	Cinzeno	Grijs	Grå	Grått	Grå	Harmaa	Sedá	Szürke	Szary

15

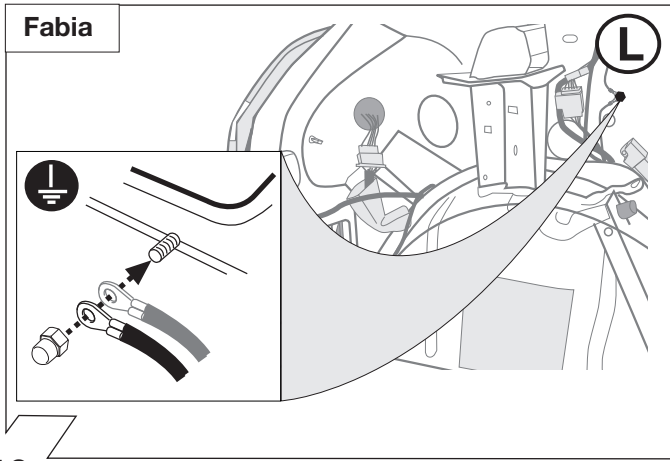

16

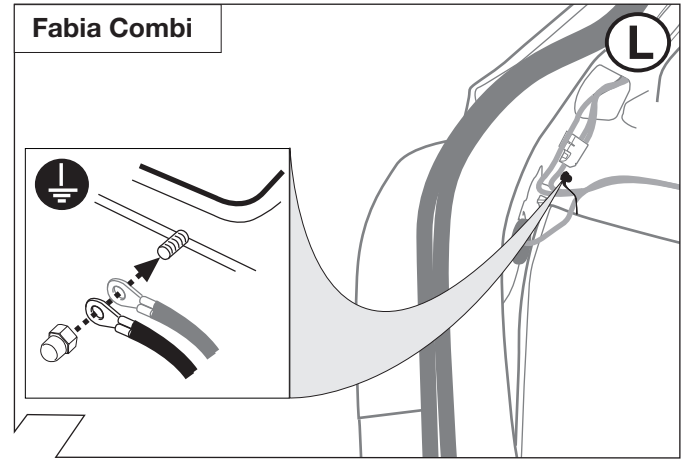

17

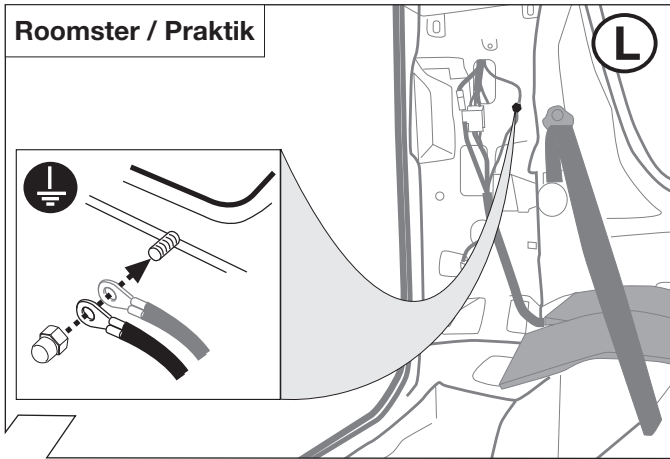

18

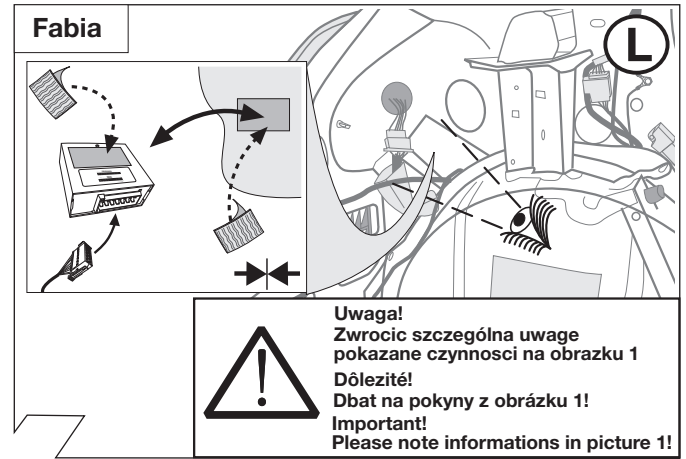

19

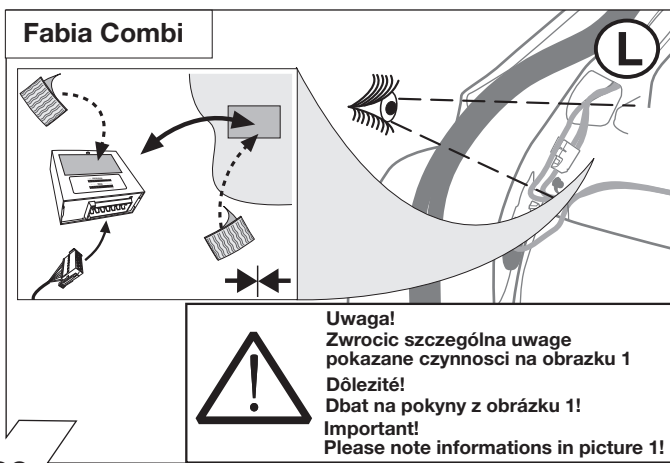

20

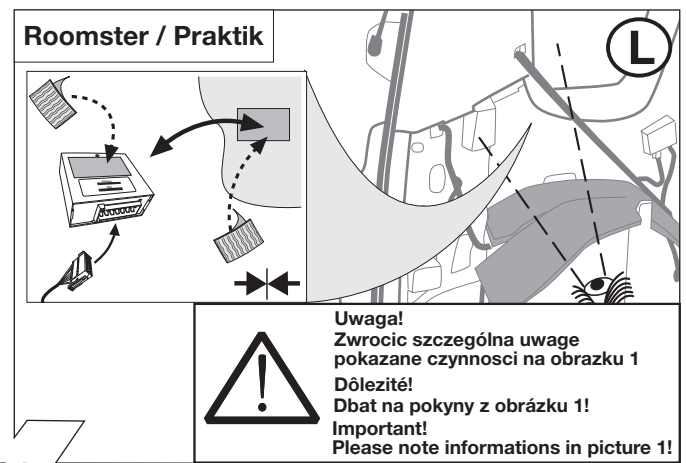

21

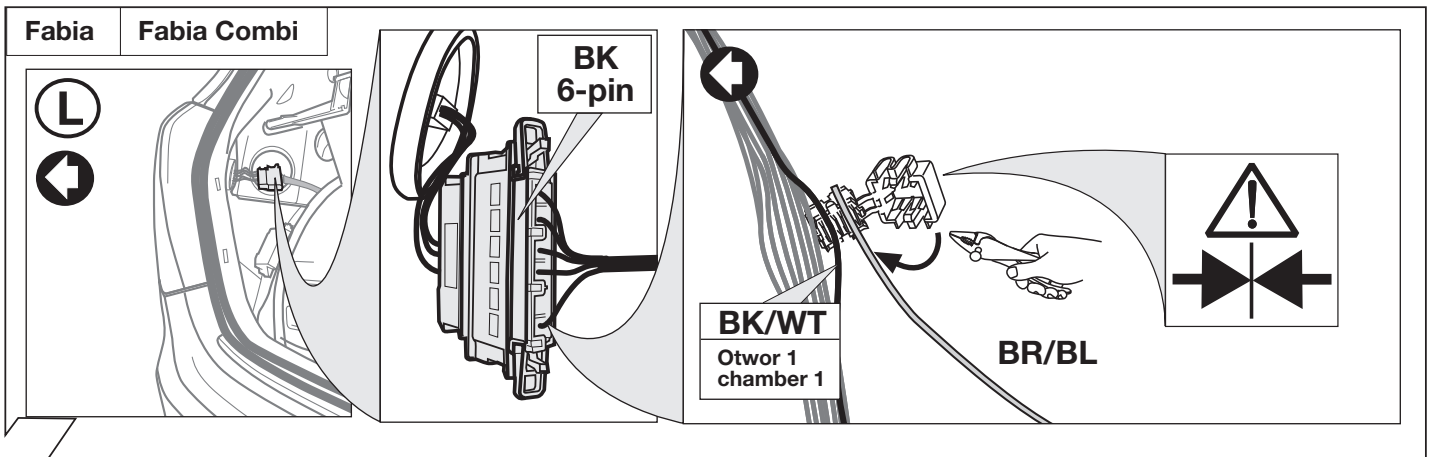

22

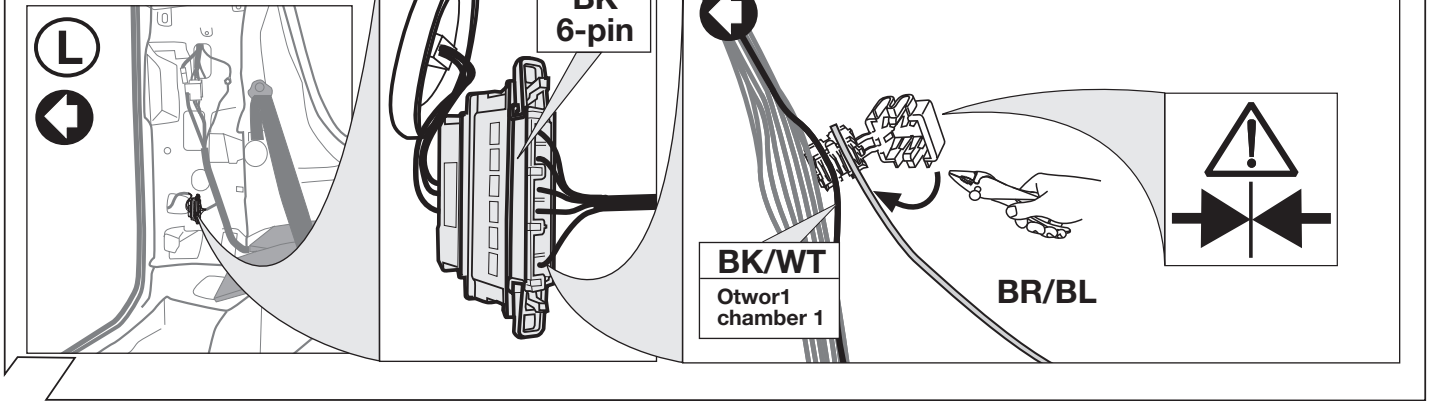

23

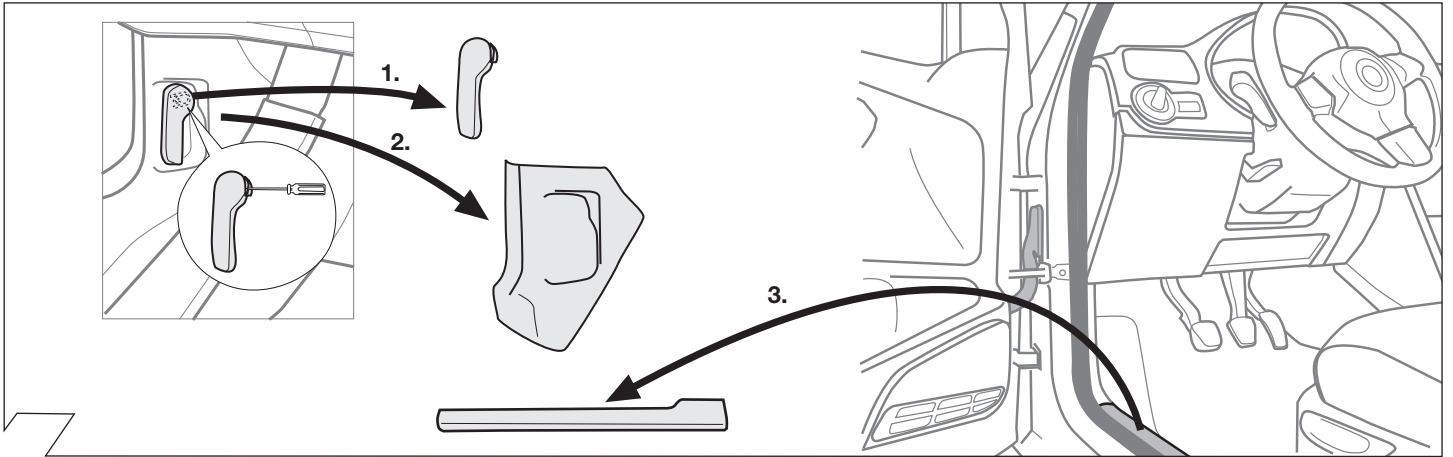

24

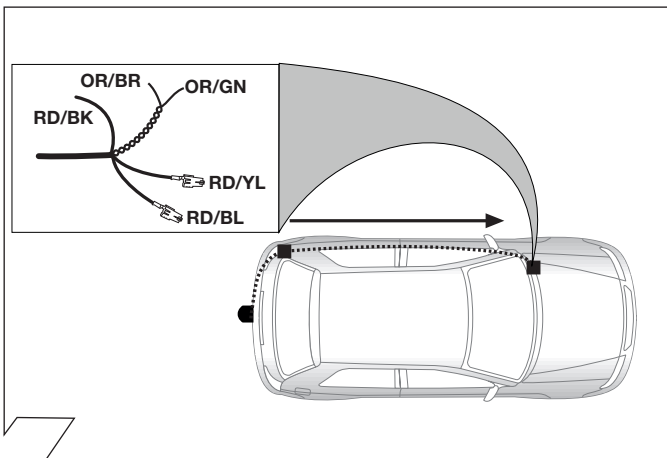

25

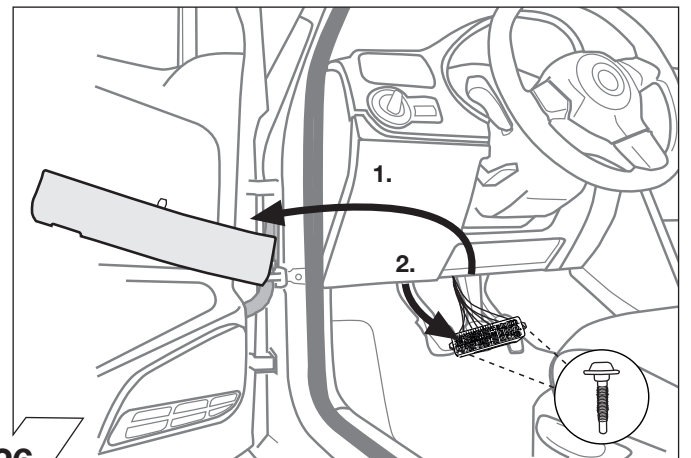

26

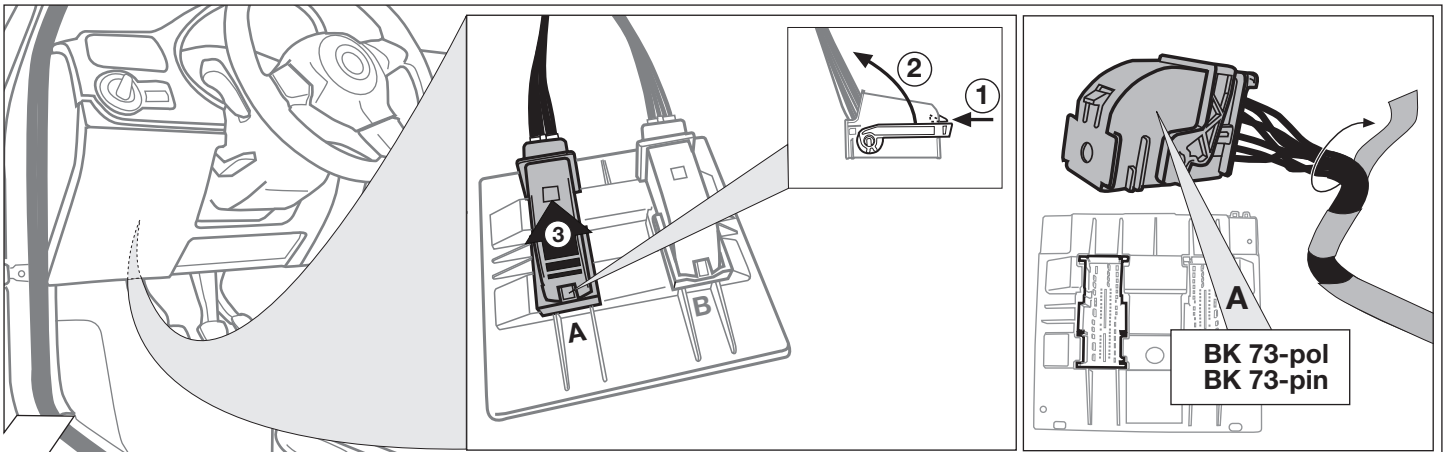

27



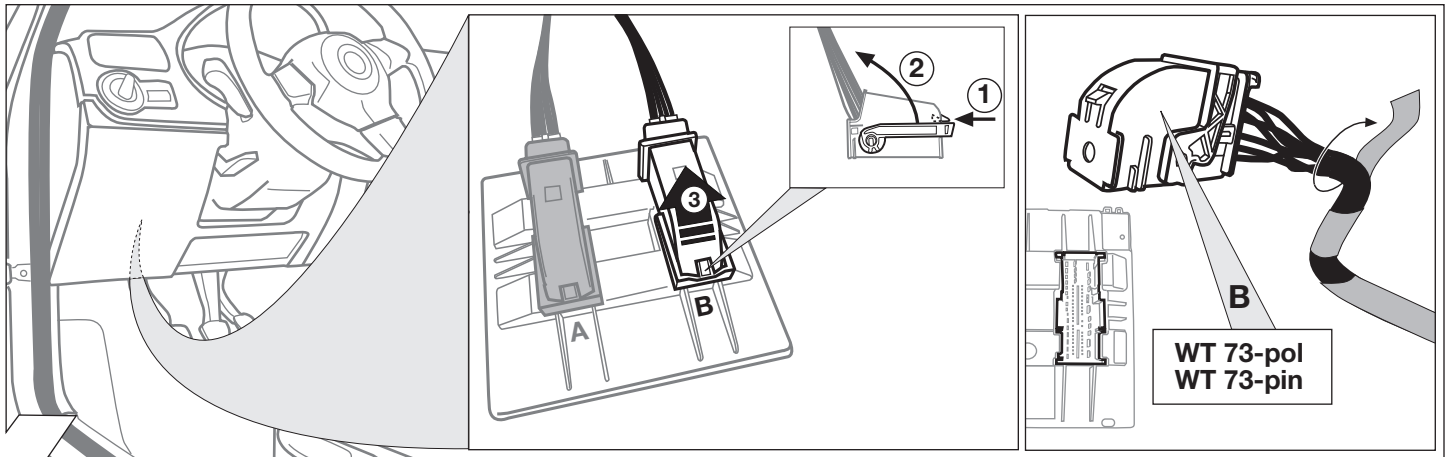

28

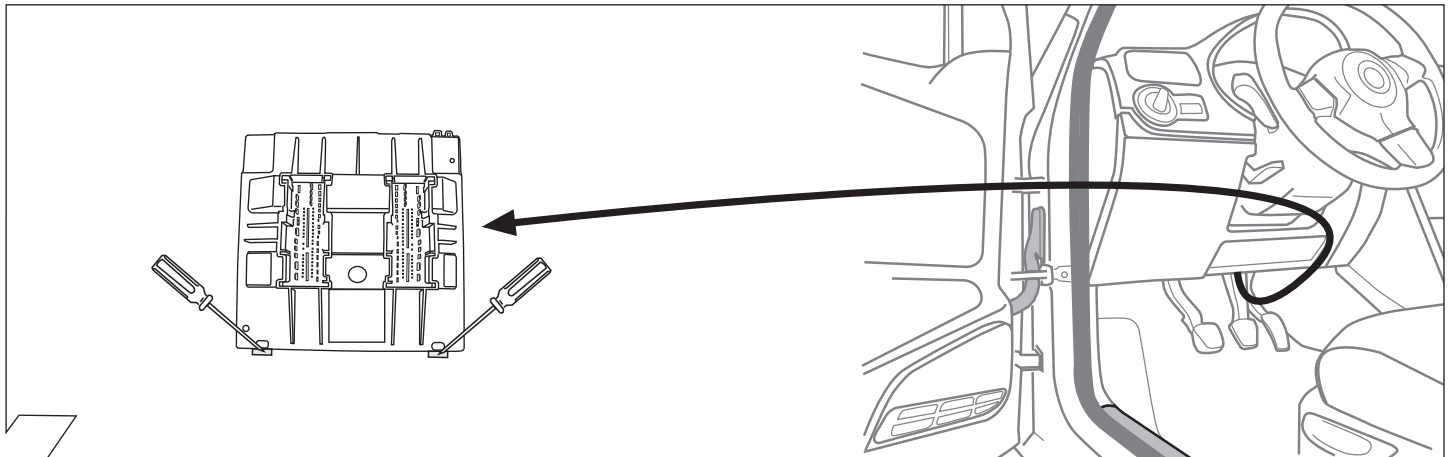

29

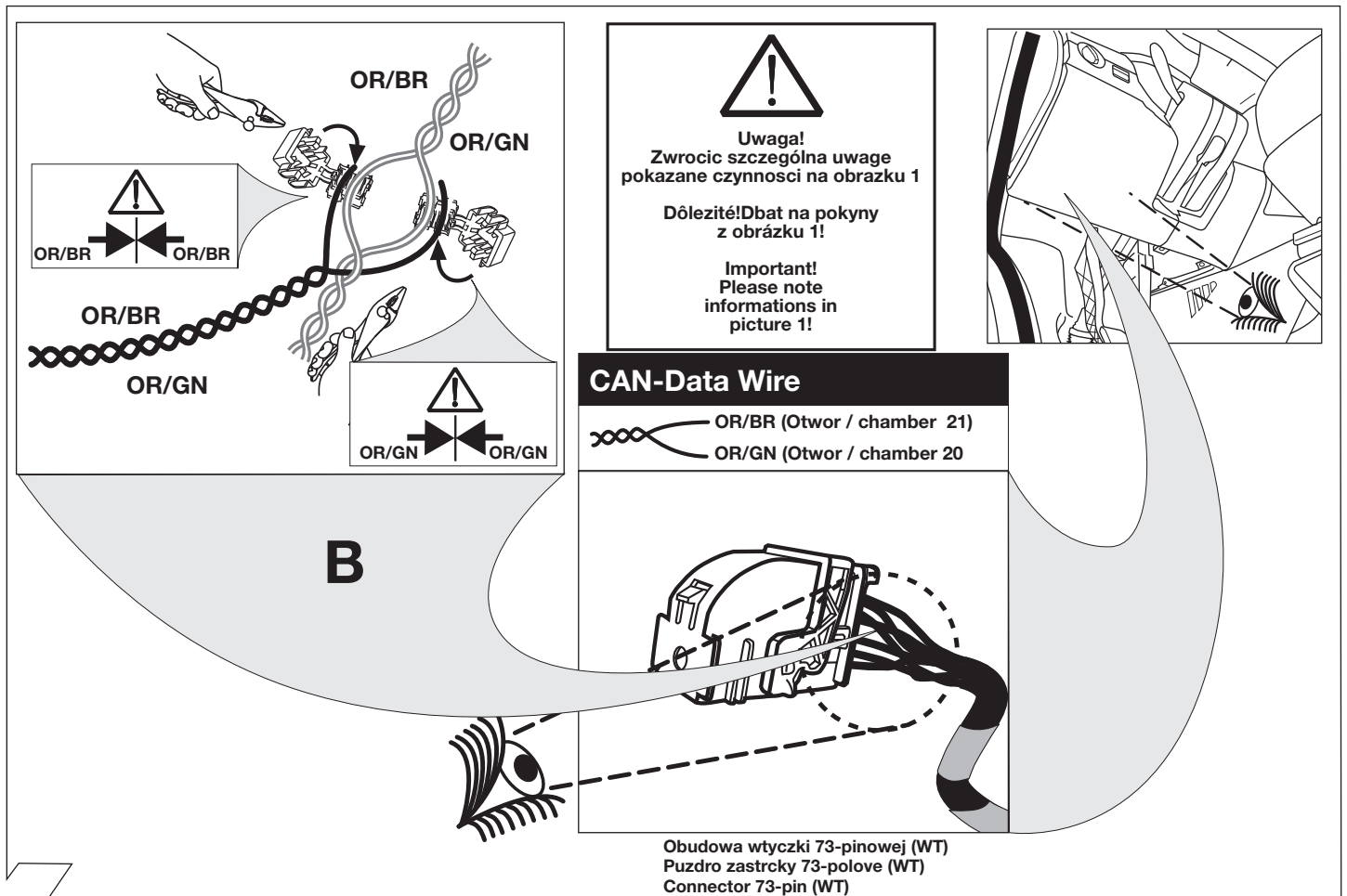

30

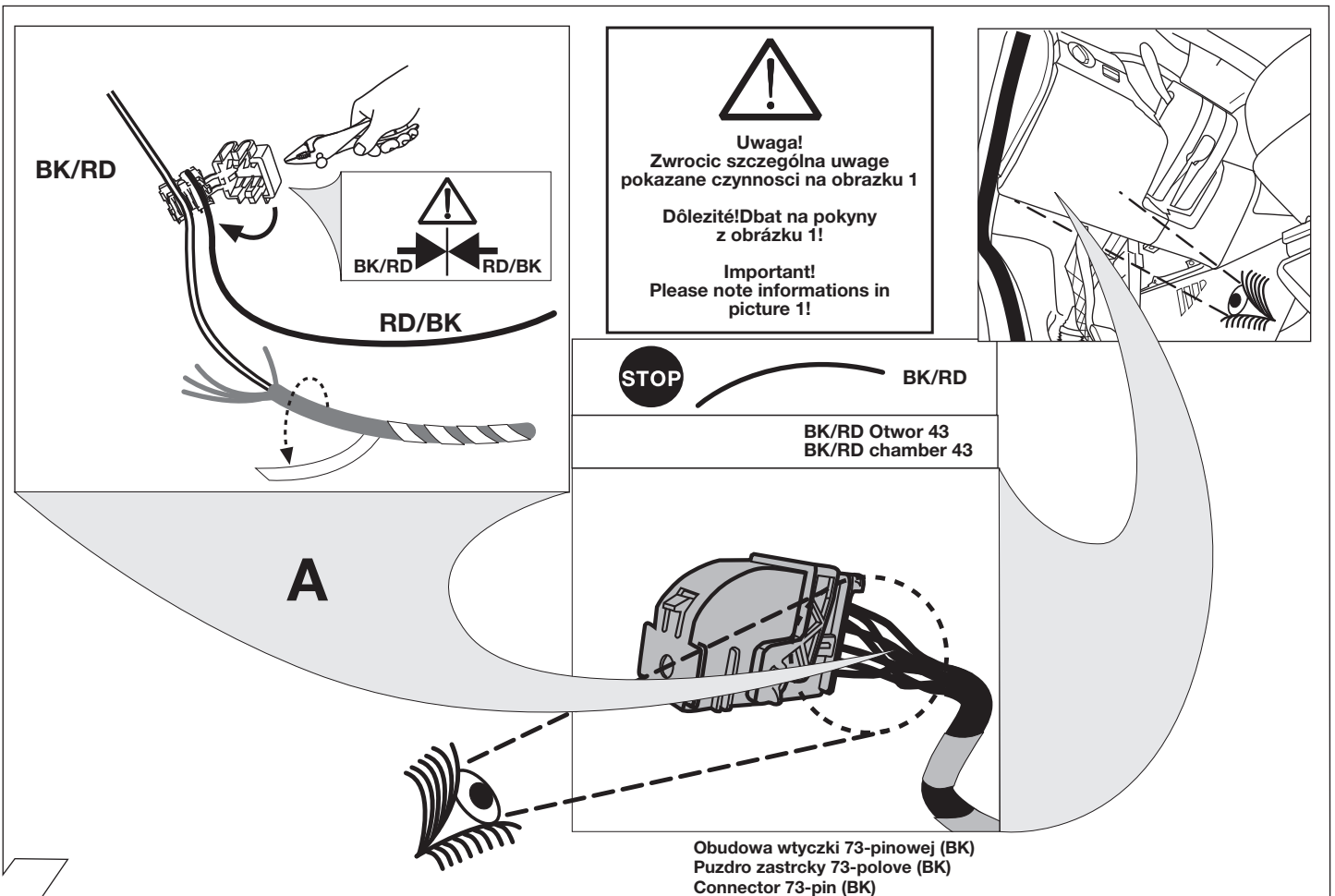

31

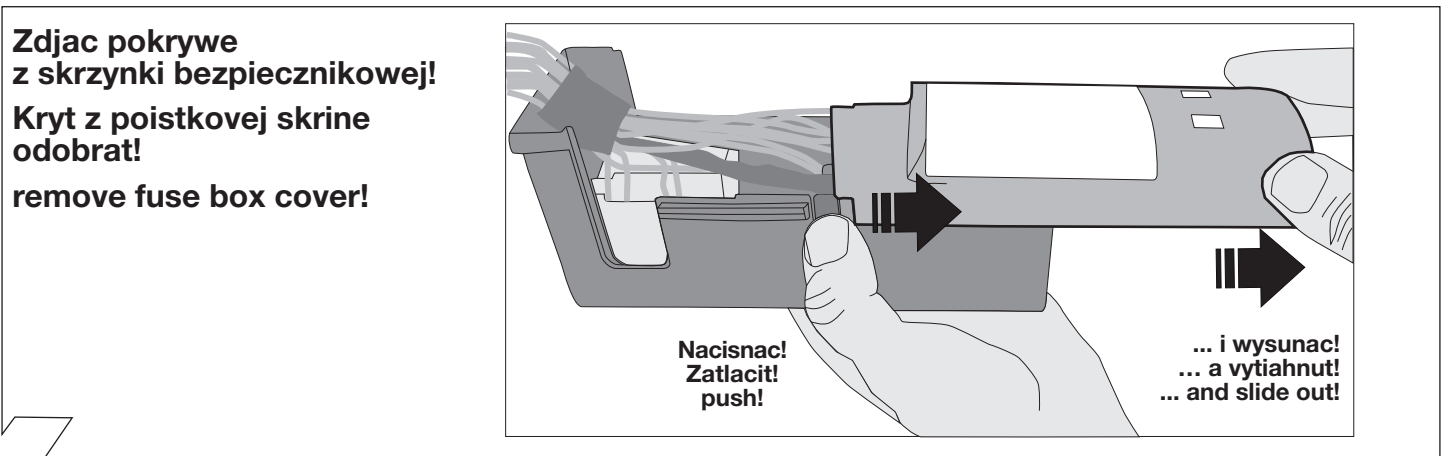

32

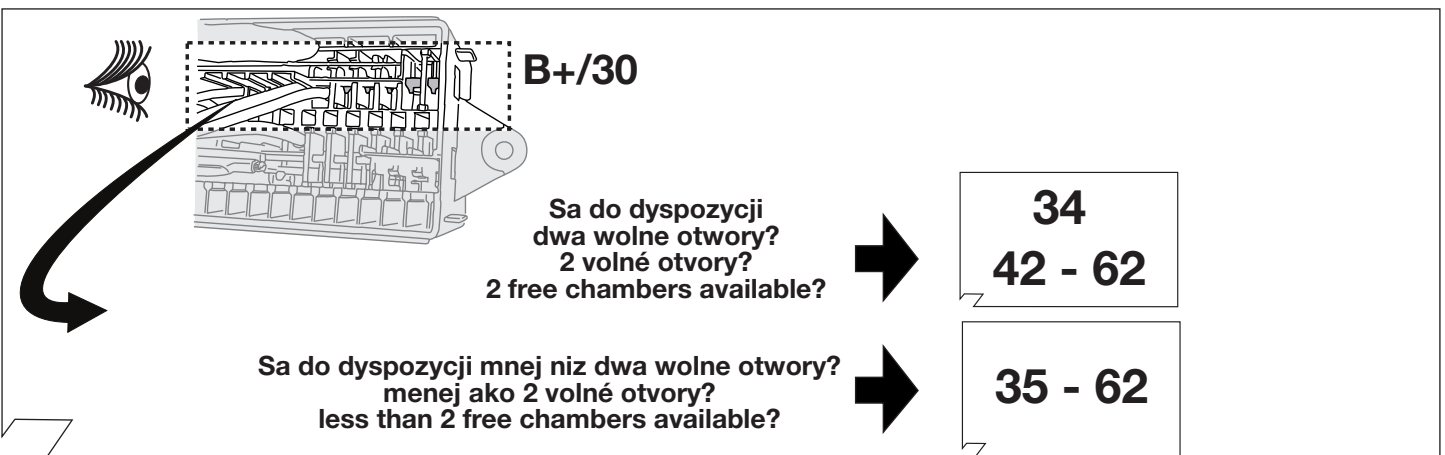

33

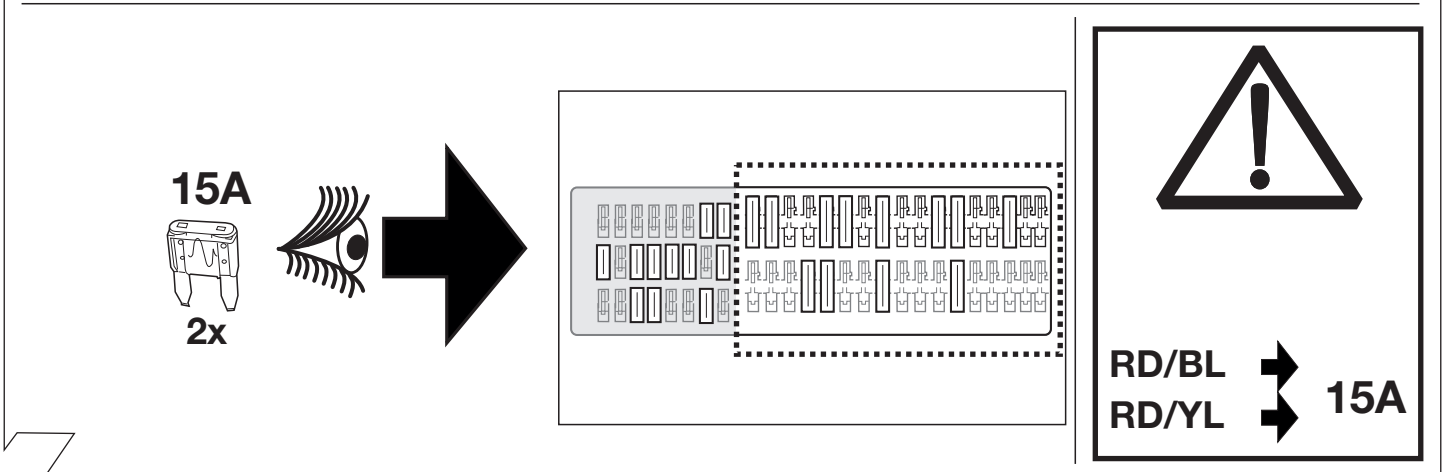
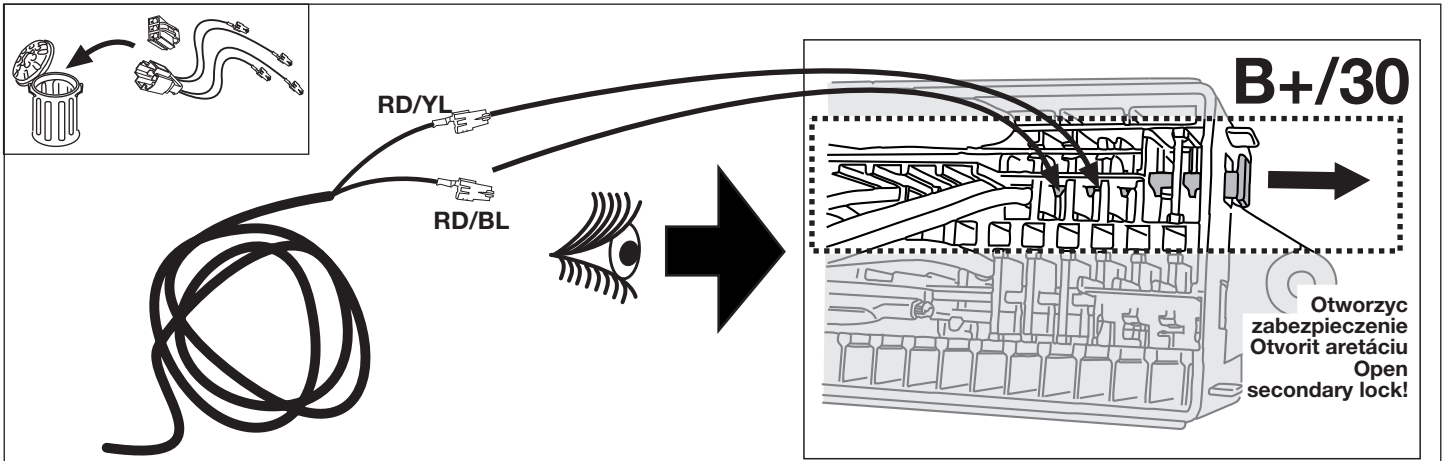

34

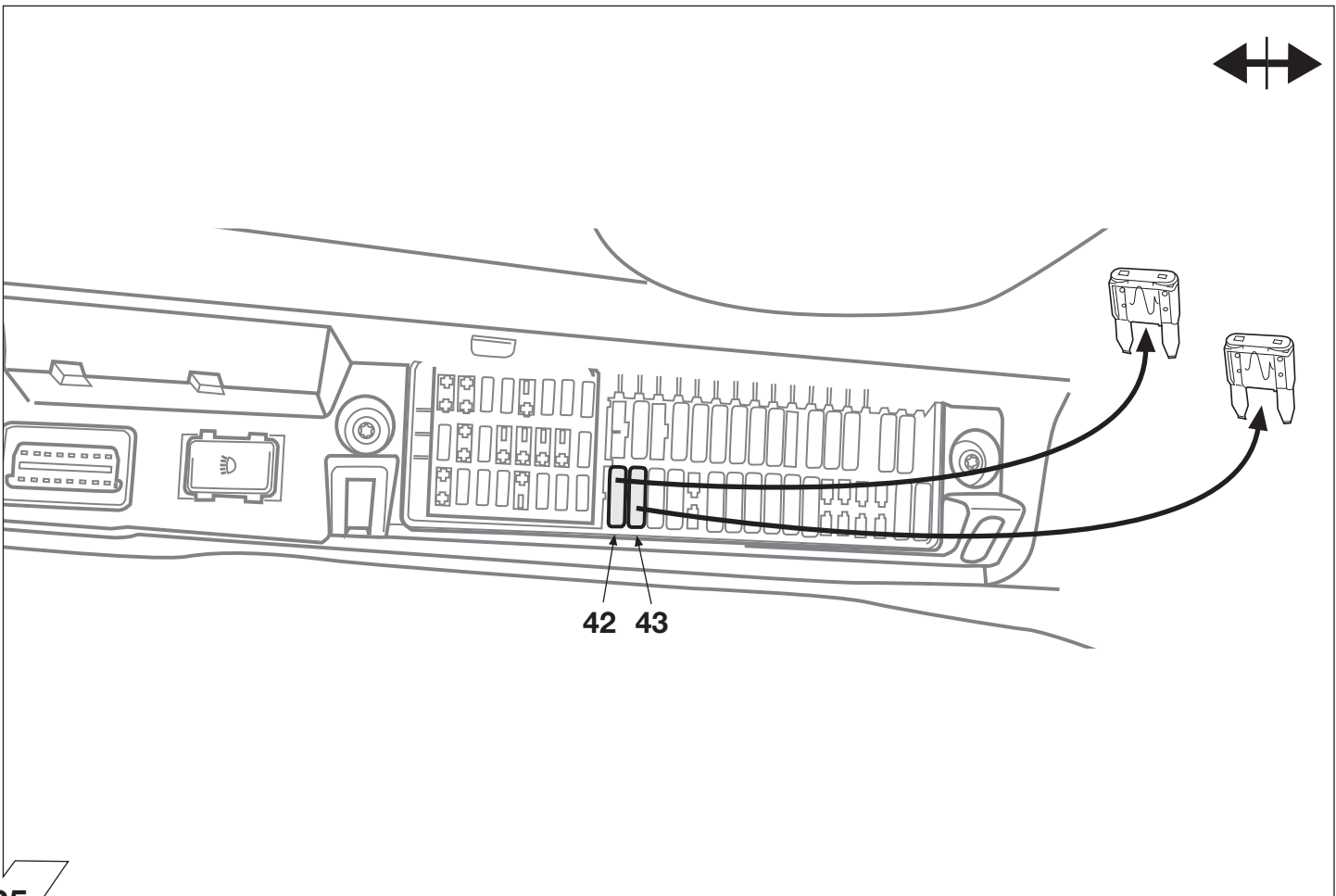

35

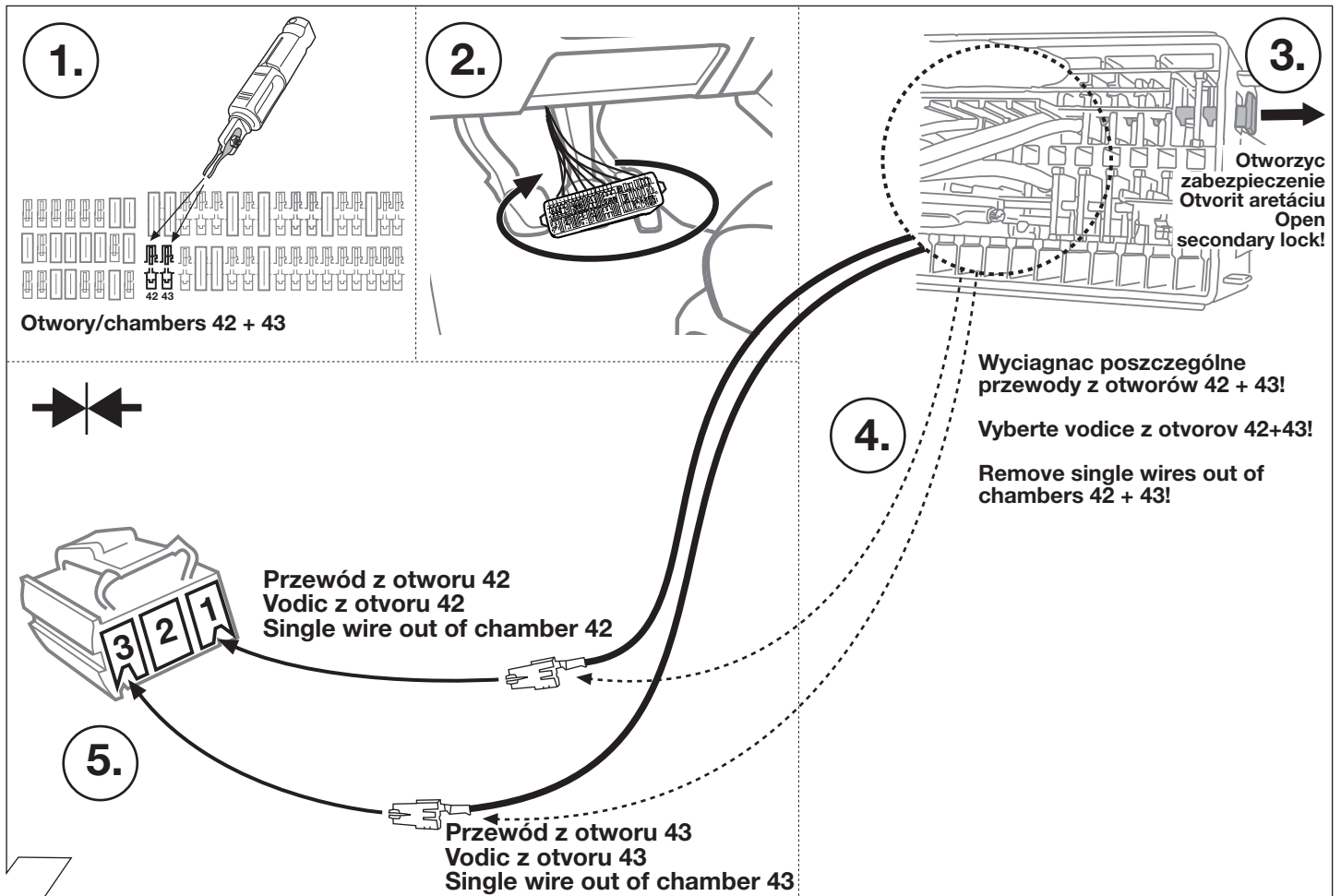

36

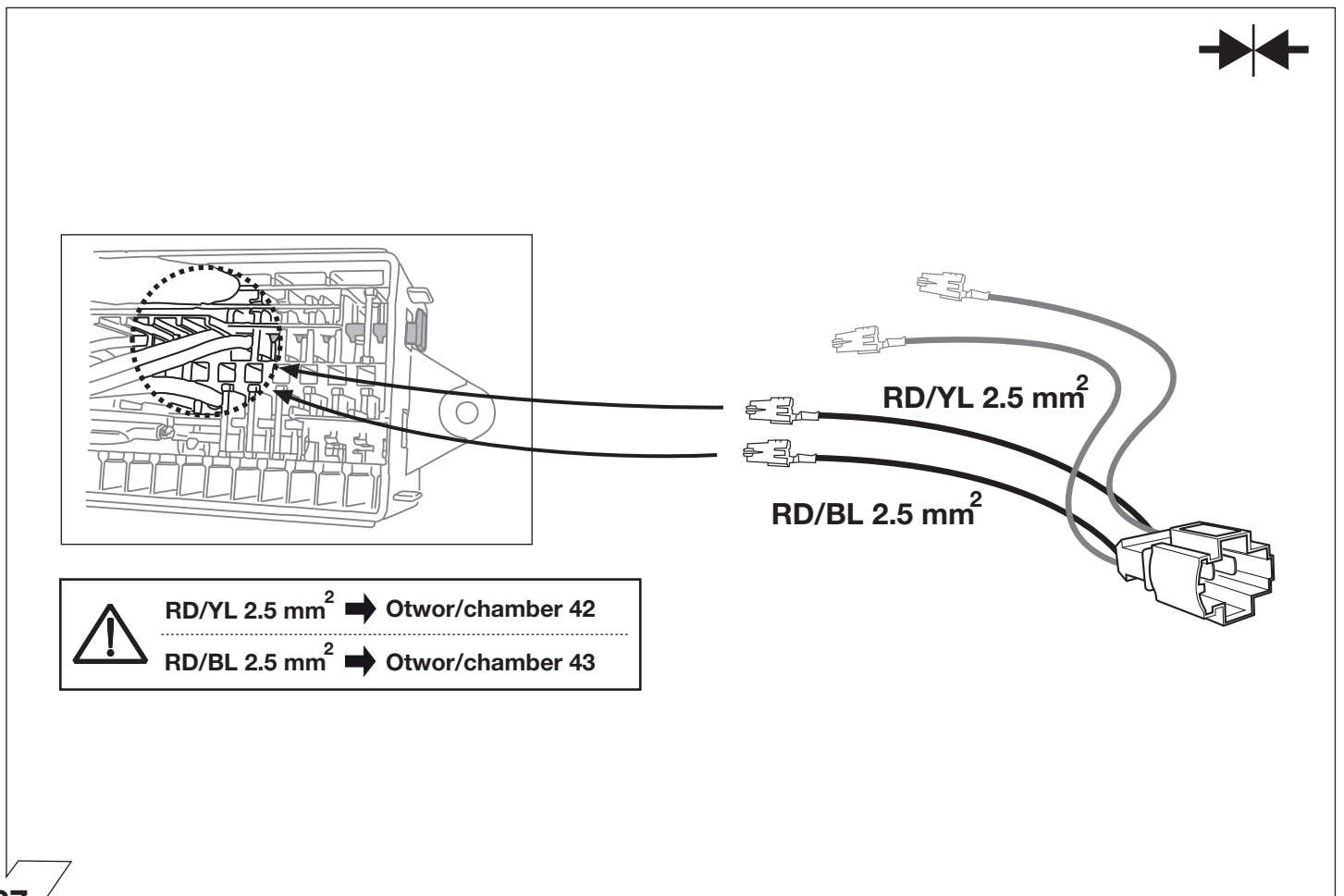

37

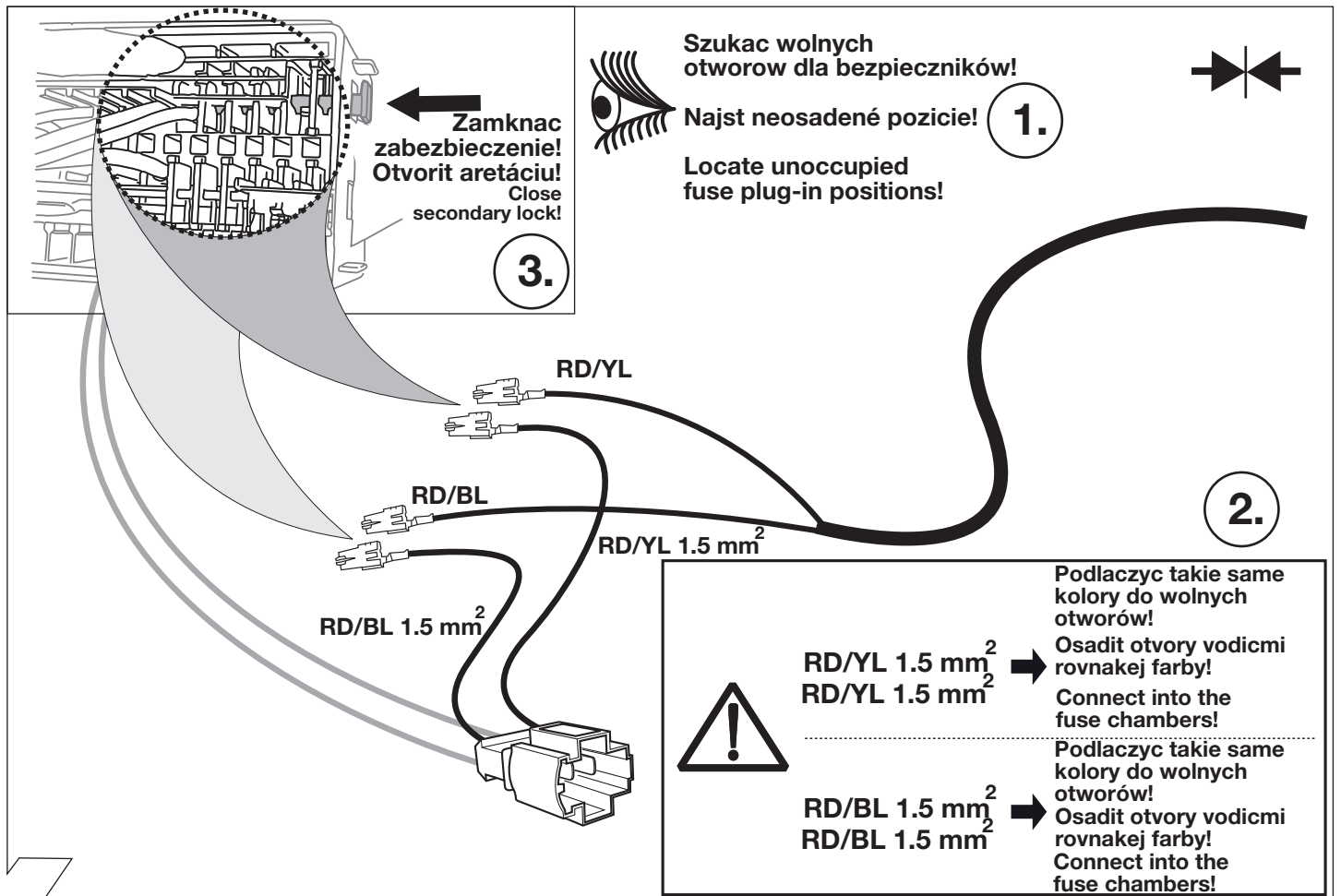

38

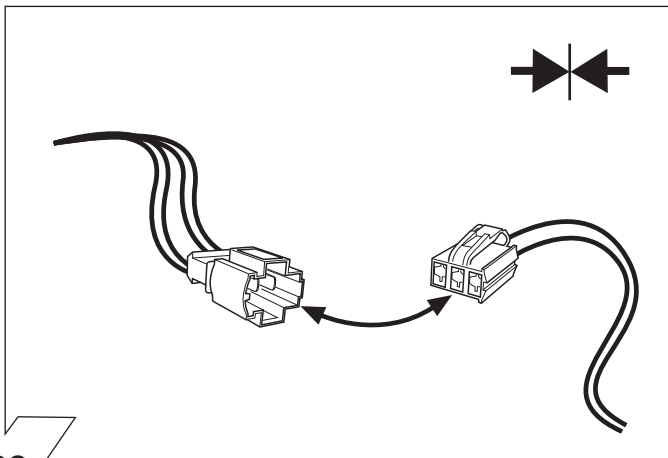



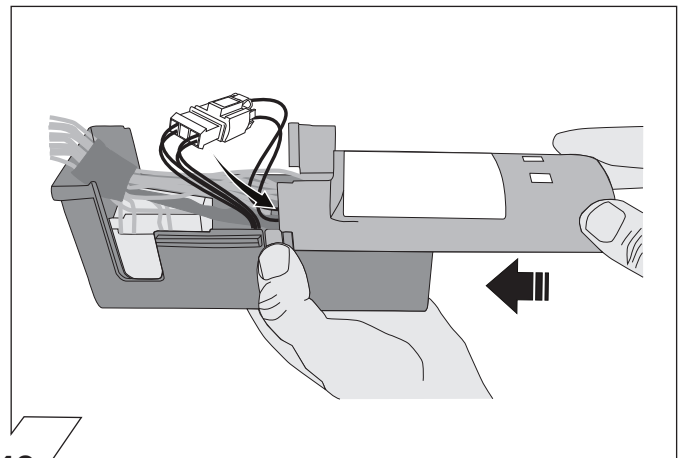

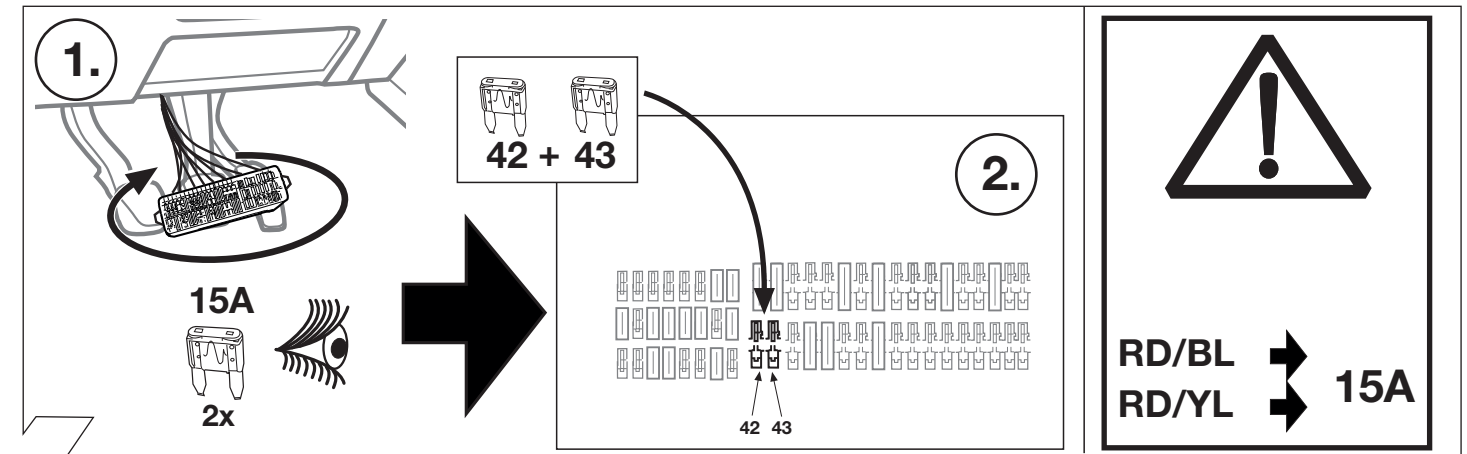

39



40

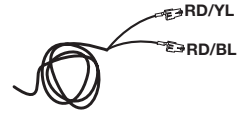



41

  POS.			 POS.
		 RD/YL 15A	<hr/>
		 RD/BL 15A	<hr/>

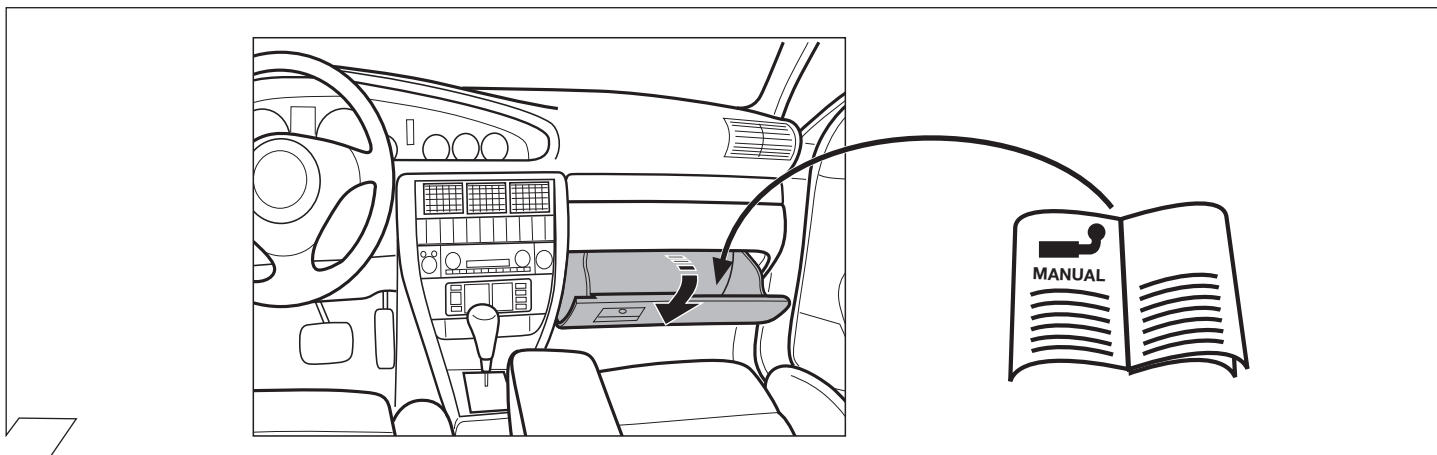
42





43

 <p>(PL)</p> <p>Niektóre funkcje oświetlenia przyczepy nie są aktywne w samochodach które są wyposażone w przełącznik świateł dziennych:</p> <ul style="list-style-type: none"> <li>• światła pozycyjne (tylne)</li> <li>• światła obrysowe</li> <li>• oświetlenie tablicy rejestracyjnej</li> </ul> <p>W celu aktywacji tych funkcji muszą być włączone światła postojowe lub pozycyjne.</p>	 <p>(SK)</p> <p>Nasledujúce funkcie osvetlenia privesu nie su podporovane pri vsetkych tahacoch so spinanim denneho svetla pocas jazdy:</p> <ul style="list-style-type: none"> <li>• koncové (zadné) svetla</li> <li>• obrysové svetla</li> <li>• osvetlenie SPZ</li> </ul> <p>K aktivovaniu týchto funkcií musí byť zapnuté parkovacie svetlo alebo tlmené svetlo.</p>	 <p>(GB)</p> <p>The following lamp functions for the trailer are not supported by all towing vehicles with DRL circuit:</p> <ul style="list-style-type: none"> <li>• Rear lights</li> <li>• Side lights</li> <li>• Numberplate lights</li> </ul> <p>The parking lights or dimmed headlights must be switched on to activate this function!</p>
--	--	---

44

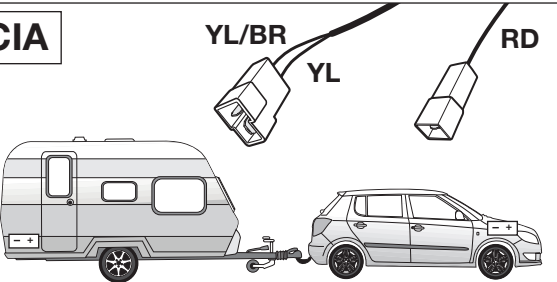
**OPCIA**



	Part-no. <b>22400509</b>
	Part-no. <b>22400001</b>

45

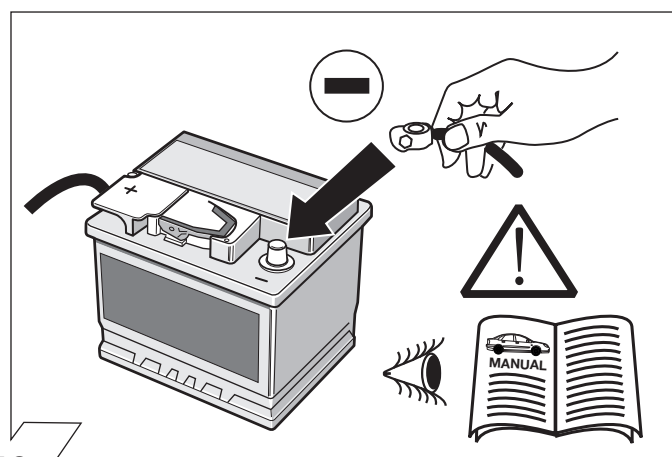

46



**Aktywacja modułu sterującego**  
**Kódoвање riadiaceho modulu**  
**Code Control unit**

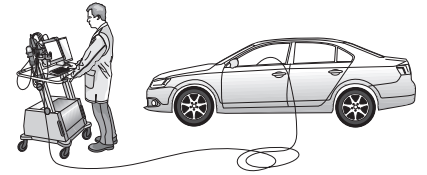
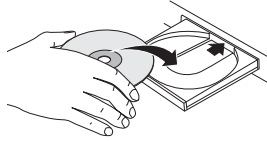

47

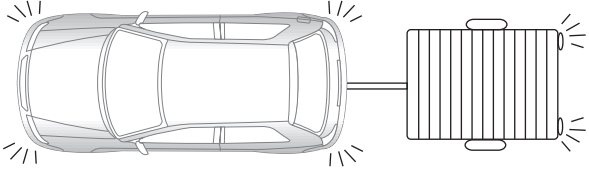
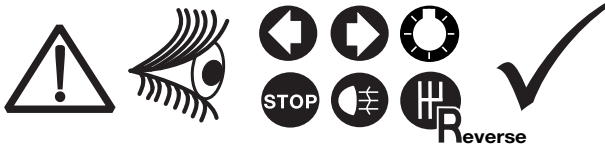

48

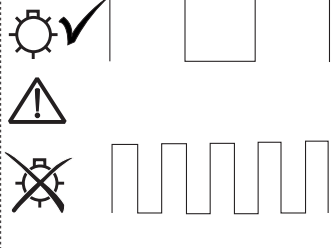
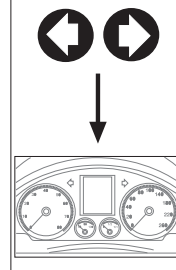

49

**OPCJA**

**Symulacja przyciepy dla gniazd 7 i 13 Pinowych.**  
**Simulator privesu pre 7- a 13-pol. zasavky.**  
**Trailer Simulator for 7- and 13-pin Sockets**

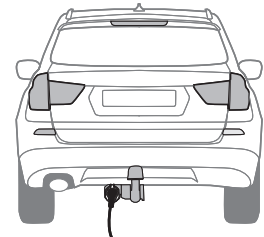
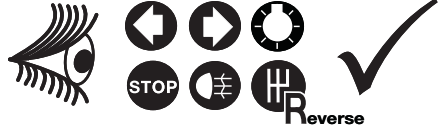
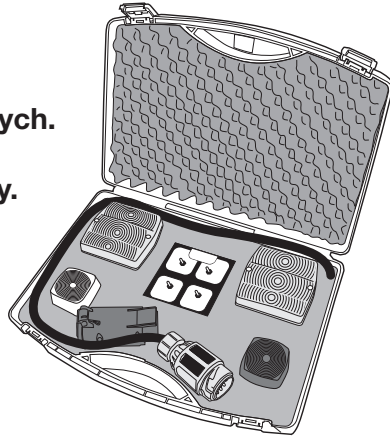

50

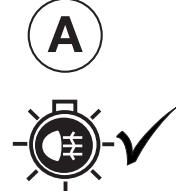
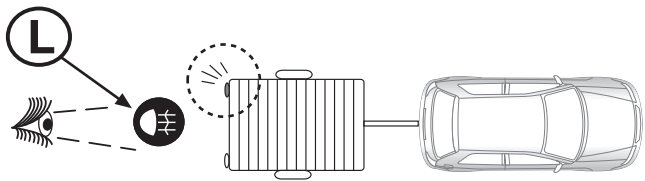

52  
60 - 62

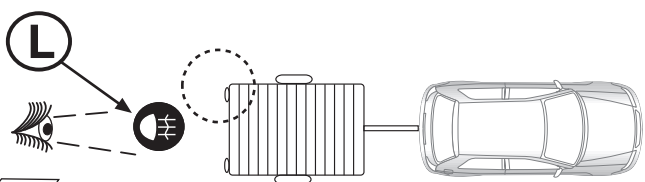

53 - 62

51

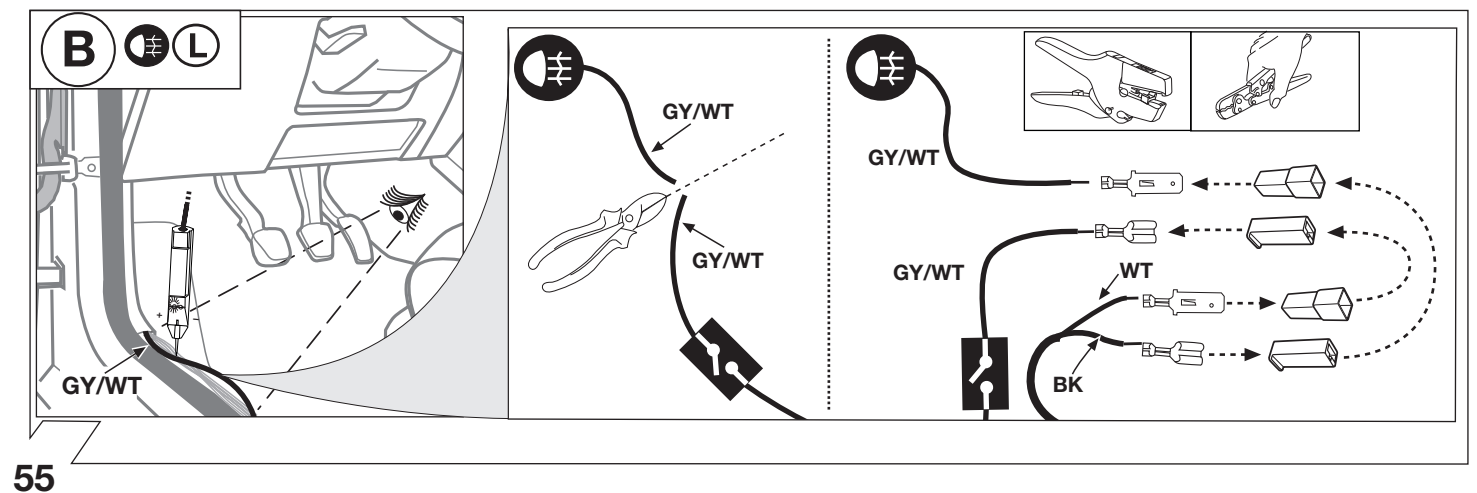
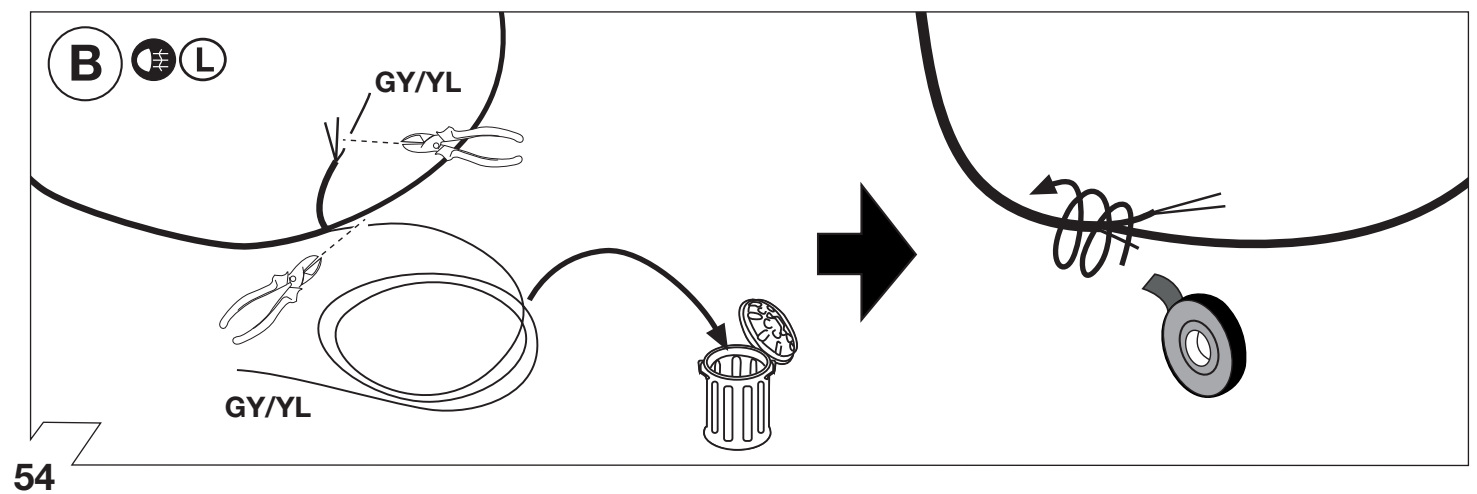
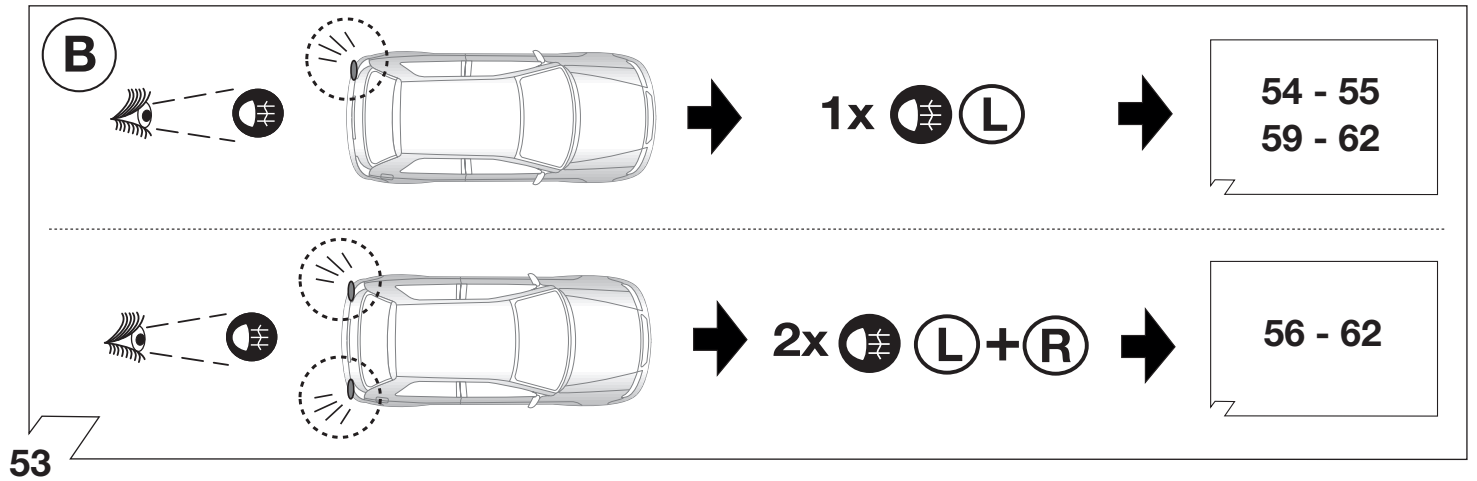
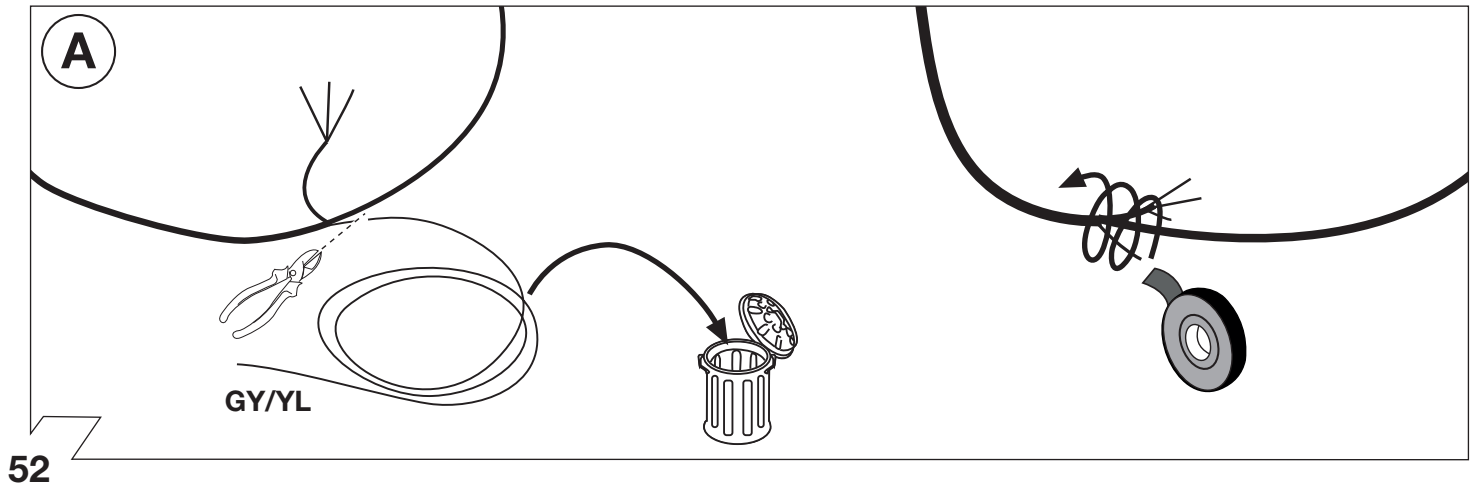



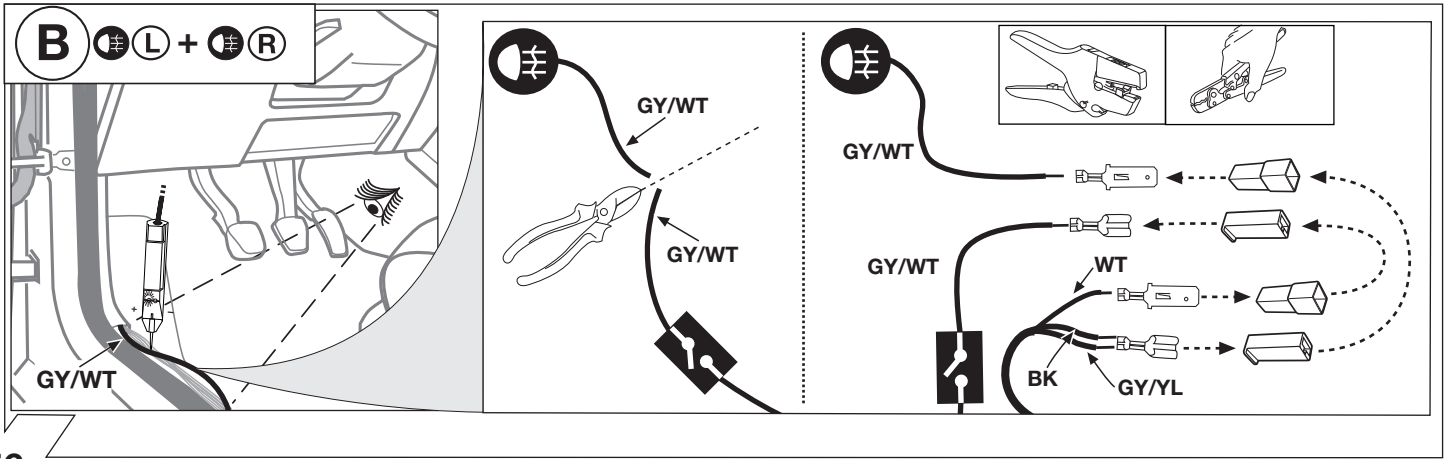

56

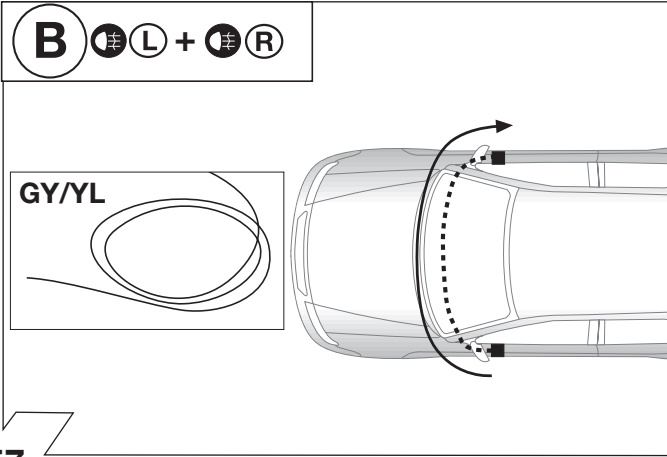

57

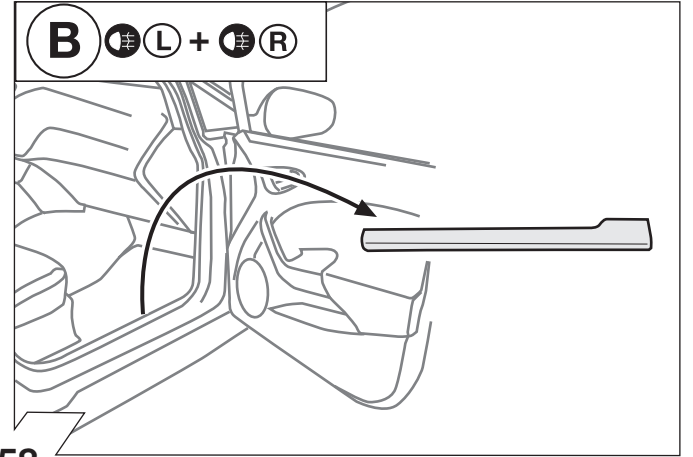

58

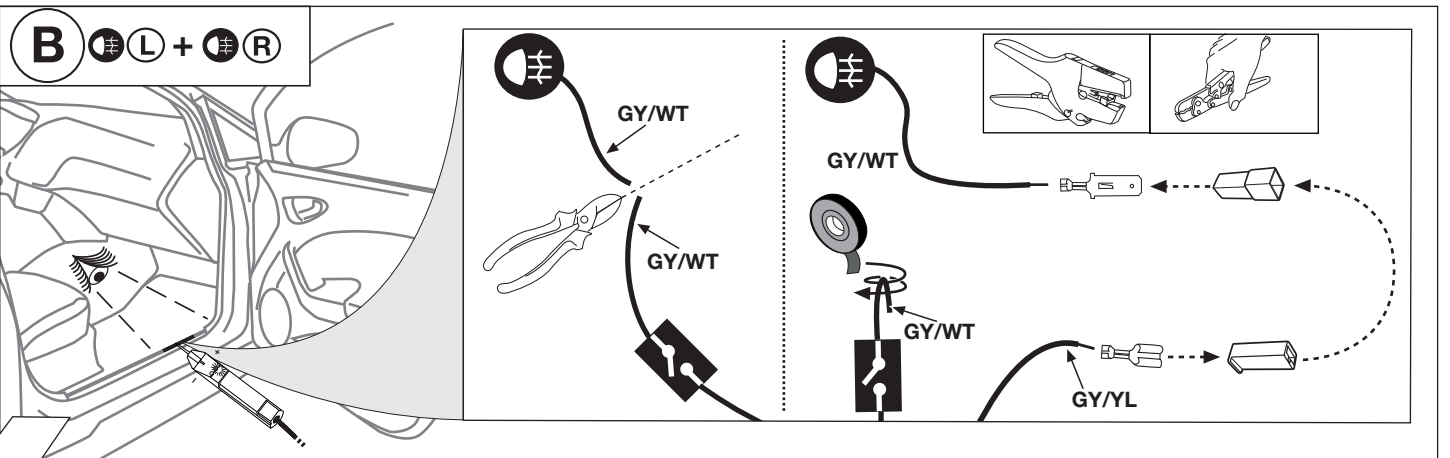

59

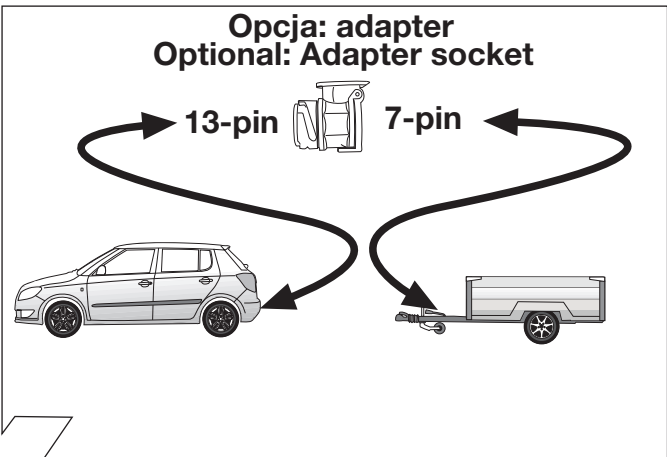

60

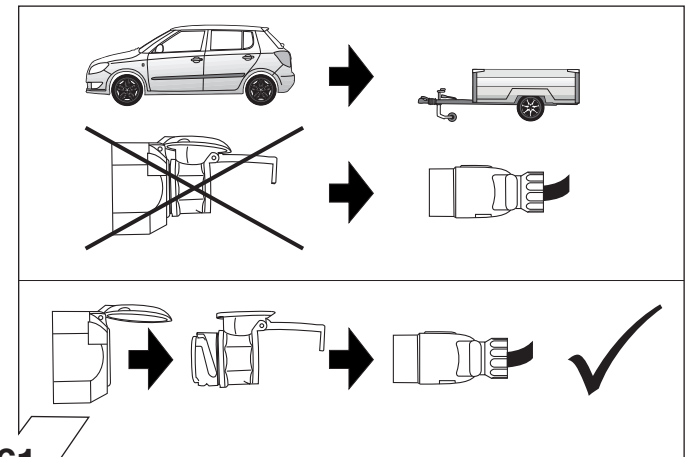

61

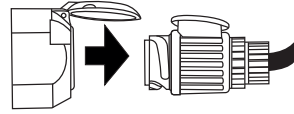
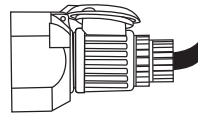

62

	Objasnienia symboli	Vysvetlivky k symbolom	SYMBOL EXPLANATION
	PL	SK	GB
	Lewe(58-L)lub prawe (58-R) koncowe swiatlo	lavé (58-L) resp. pravé (58-R) koncové svetlá	left (58-L) respectively right (58-R) tail light
	Swiatlo stop (54)/ trzecie swiatlo stop (54)	Brzdové svetlá (54)/ tretie brzdové svetlá (54)	stop light (54) / high mounted, third stop light (54)
	Kierunkowskaz lewy	Smerové svetlo lavé	turn signal indicator left
	Kierunkowskaz prawy	Smerové svetlo pravé	turn signal indicator right
	przeciwmgielne swiatlo	Hmlové svetlo(á)	rear fog light(s)
	swiatlo wsteczne	Spätné svetlo (á)	reversing light(s)
	staly plus/gniazdo 13 biegunowe, kontakt 9	Trvalé plus/zásuvka 13 polová, kontakt 9	Permanent power supply / 13pin socket, chamber 9
	przewód ladujcy/gniazdo 13 biegunowe, kontakt 10	Nabijací kábel/ zásuvka 13-polová, kontakt 10	charging wire for trailer fridge / 13pin socket, chamber 10
	przyczepa / rozpoznanie przyczepy	Príves / rozpoznanie prívesu	trailer / trailer recognition
	staly plus/stale napiecie	Trvalé plus/stály prúd	Permanent current power supply
	masa 31	Kostra (31)	Ground or Earth (31)
	klema baterii - minus	Pólová svorka batérie - minus	ground connection battery terminal lug
	klema baterii - plus	Pólová svorka batérie - plus	positive connection battery terminal lug
	Bezpiecznik/ amperaz 20A	Poistka / Vykon poistky 20 Ampère	fuse / fuse capacity 20 Ampère
	Zapalniczka / gniazdo uzupelniajace	Zapalovac / doplnková zásuvka	cigarette lighter / accessory socket
	klakson	Reproduktor/húckacka	loudspeaker / buzzer
	czujnik(sensor) parkowania	Parkovací senzor	park distance control
	Przelacznik	Prepínac/zdroj funkcie	switch / source of function
	polczyc	Spojít	Connect together
	rozlaczyc	Rozpojit	disconnect
	sledzic / patrz nastepne informacje	Sledovat / vid. dalsie informácie	Look at / see further information
	sledzic/wybrana czesc	Sledovat vybranú oblasť	look carefully at selected area
	znajdujacy sie / w porzadku	Nachádzajúci sa / osadeny/v poriadku	Present / Occupied / OK
	nie znajdujacy sie / nie w porzadku	Nenachádzajúci sa/neosadeny/ nie v poriadku	Not present / Not occupied / not OK
	na lewo	Nalavo	left
	na prawo	Napravo	right
	dzwiekowa sygnalizacja	Zvuková signalizácia	acoustic indication
	Uwaga / wazna informacja	Pozor / dôležitá informácia	attention / important advice